

Line-Voltage Regulators

GR Variac® automatic line-voltage regulator	Output Current <i>at nominal input voltage of</i>			Input Frequency (Hz)		
	115 or 120 V	230 or 240 V	460 V	50	60	400
1591 (portable)	8.7 A				●	
1592	to 44 A	to 42 A		●	●	
1571 (militarized)	to 50 A			●	●	
1581	to 50 A	to 40 A		●	●	●
1582	to 85 A	to 85 A	to 34 A	●	●	●

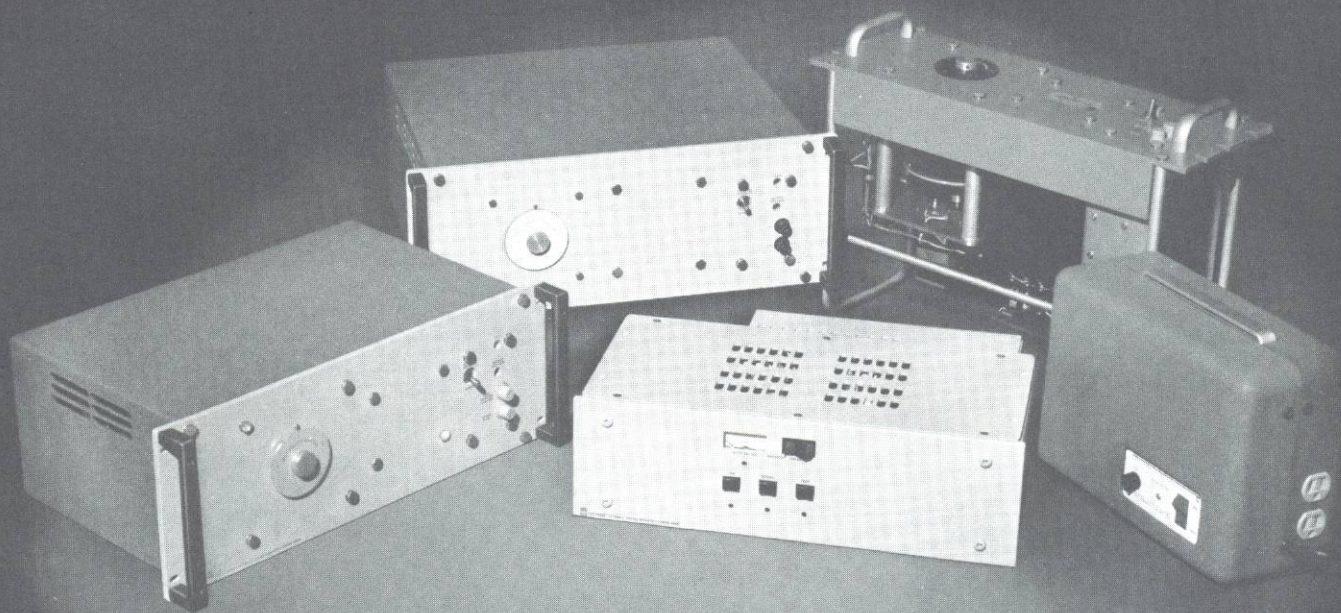

Variac® automatic voltage regulators

The answer to line-voltage problems If your problem is poor process control, computer errors, inaccurate instrumentation, overheated motors, cool heaters, or other assorted equipment aberrations, an excellent solution is a General Radio Variac® automatic line-voltage regulator.

GR regulators have many advantages for both laboratory and industrial use in any application where controlled line voltage is needed, and they are particularly valuable to offset the effects of brownouts.

There are 5 basic models of GR regulators and over 100 variations, plus units built to your specifications. All offer outstanding performance characteristics:

- Regulation to 0.2%
- Insensitive to load type, they work equally well on all loads from open circuit to maximum rating
- Up to 10 times rating for transient surges
- Introduces no distortion or noise
- No power-factor restrictions
- Fast response, comparable with magnetic types
- Reliable solid-state controls

Simple, smooth operation The regulator comprises a motor-driven Variac® adjustable autotransformer, an auxiliary step-down transformer that multiplies the power rating of the autotransformer in the larger models, and a solid-state control unit that automatically positions the autotransformer to hold the output voltage constant.

The regulator's output voltage is compared to a reference voltage and the resultant error signal controls a servo motor to provide a true proportional-control system, rather than an on-off circuit. The accompanying oscillograms illustrate a typical response to a 2% step change in line voltage. The traces are greatly expanded and show only the ac voltage peaks.

The use of a true proportional-control system provides not only fast correction but also smooth control of voltage, completely free of the voltage jumps introduced by an on-off control system. The absence of relays provides long trouble-free life, and tolerance of 1000% transient overloads is made possible by the Duratrak® commutator surface of the Variac autotransformer.

The regulators maintain an undistorted output that is corrected to the limits of the correction range; i.e., if the input to a 10% regulator varies 15%, the output will vary only 5%.

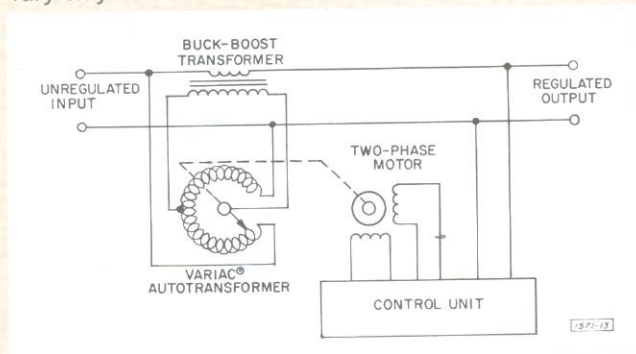

Elementary schematic diagram of General Radio voltage regulators.

Single-phase selection The proper regulator for your application depends on your input-line characteristics and the output characteristics desired from the regulator. GR regulators cover the following conditions:

INPUT Frequency: 50, 60, or 400 Hz.

Nominal Voltage: 115 or 120 (also 230 and 460) V.

Range of inputs, with regulation: 72 to 156 V.

OUTPUT Voltage: 90 to 130 V, adjustable

Current: 8.7- to 85-A ratings

The input range for most GR regulators is expressed as a percentage of the output voltage (± 5 , ± 10 , ± 20 , or $+24 - 18\%$). For example, if the output is set to 100 V on a regulator with a $\pm 10\%$ range, the input can vary from 90 to 110 V and the regulator will maintain a constant 100-V output. Under some conditions for three-phase systems, this range can be appreciably increased; see below, under Three-Phase Selection, three-wire inputs.

Output-current rating is a function of the input range — the greater the range, the less the current capability. (For a given voltage model, the input range can easily

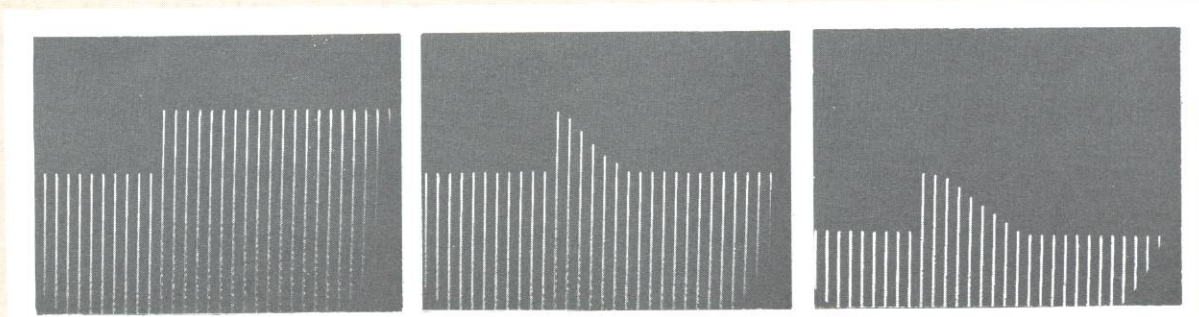

Oscillograms of line-voltage peaks show response speed of Variac® automatic voltage regulators: left, 2% step change in line voltage; center and right, resulting output transients for 1581 and 1582 Regulators, respectively.

be changed in the field.) Thus a GR 1592 regulator rated at 44 amperes for a $\pm 10\%$ range is rated at 20 amperes for a $\pm 20\%$ range. Detailed information is included with the descriptions of each GR regulator to allow you to select the best regulator for your application. Additional information or advice is readily available from any GR sales office whenever you may need it. The Regulation Ranges graph and examples on these pages are intended to allow you to select the basic type of GR regulator you may need and to acquaint you with some of the techniques involved in getting the most for your money.

Example 1 Your input is nominally 115 or 120 V, 60 Hz, and your load requires up to 5 A. For this, any basic GR regulator is satisfactory. You specifically desire a 115-V output and you've determined your line voltage varies from 95 to 130 V. This restricts your choice slightly, since the GR 1591 will not regulate with an input below 100 V.

Example 2 Suppose your requirements are similar to example 1 except you've discovered the input may go as low as 90 V. Under these circumstances, no GR regulator appears suitable. However, since your 115-V output requirement is not critical (many devices operate properly over a range of voltages, such as from 105 to 125 V), you decide an output of 110 V is adequate. It is now apparent that any GR regulator, except the 1591, is again suitable.

Example 3 In this case the initial conditions are the same as example 2 except that the output voltage must be exactly 100 V. The 1592 is the only regulator that will provide this output; and the input range is 80 to 120 V.

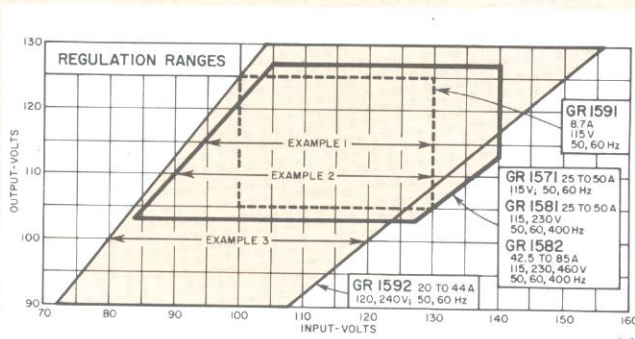

Information is shown for 115- and 120-V, 60-Hz models. For 230-V models, multiply voltages and divide current ratings by 2 (for 460-V models, by 4). The regulation range is slightly less for 400-Hz models but is significantly greater in some three-phase applications. (See Three-Phase Selection, three-wire inputs.) More detailed information, particularly current ratings, is given with the descriptions of the individual regulators.

Three-phase selection All GR regulators can be used in three-phase systems. The choice of the regulator used and the number required depend on the number of input lines (three- or four-wire) and the configuration used to connect the regulators.

For three-wire inputs, the regulators can be connected in either an open-delta or a closed-delta configuration. In open delta, only two regulators are required and their input range is the same as that for single-phase systems. In closed delta, three regulators are required but their input range is increased by slightly over 50%. For four-wire inputs, three regulators are connected in a wye configuration and their input voltage requirements are reduced to about 58% of that normally required.

The individual regulators are selected on the same basis as those used for single-phase systems, once the nominal voltage has been determined.

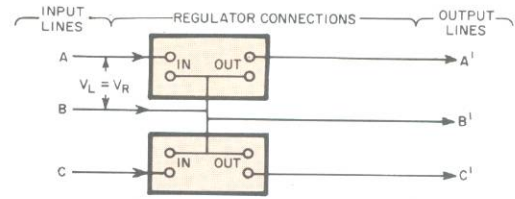

OPEN DELTA The input voltage to each regulator (V_R , A to B or B to C) is equal to the line-to-line voltage (V_L), i.e., $V_R = V_L$.

V_L Line-to-Line	V_R Input to Regulator	Basic Regulator Required
208 V	208 V	230-V nominal voltage
230 to 240 V	230 to 240 V	230-V nominal voltage
460 to 480 V	460 to 480 V	460-V nominal voltage

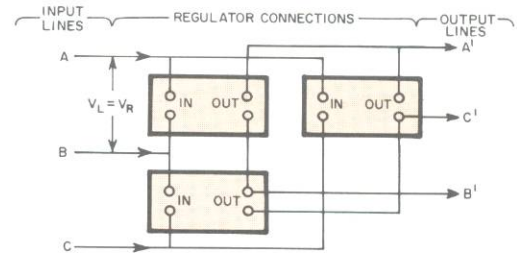

CLOSED DELTA The input voltage to each regulator (V_R , A to B, B to C, or C to A) is equal to the line-to-line voltage (V_L); i.e., $V_R = V_L$. The input range increases by slightly over 50%. Thus, the input range increases to ± 7.5 , ± 15 , ± 31 , and $+37 - 28\%$ from the normal ± 5 , ± 10 , ± 20 , and $+24 - 18\%$, respectively.

V_L Line-to-Line	V_R Input to Regulator	Basic Regulator Required
208 V	208 V	230-V nominal voltage
230 to 240 V	230 to 240 V	230-V nominal voltage
460 to 480 V	460 to 480 V	460-V nominal voltage

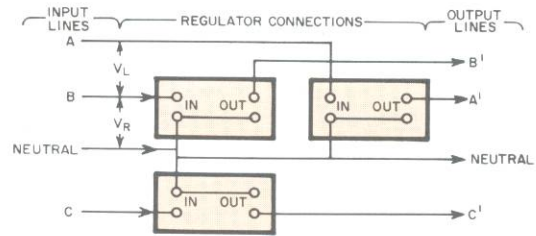

WYE The input voltage to each regulator (V_R , A, B, or C to neutral) is equal to the line-to-line voltage (V_L , A to B, B to C, or C to A) divided by 1.73. This reduces the input voltage requirements to about 58% of that normally required.

V_L Line-to-Line	V_R Input to Regulator	Basic Regulator Required
208 V	120 V	115 or 120-V nominal voltage
230 to 240 V	133 V	115 or 120-V nominal voltage
460 to 480 V	266 V	230 or 240-V nominal voltage

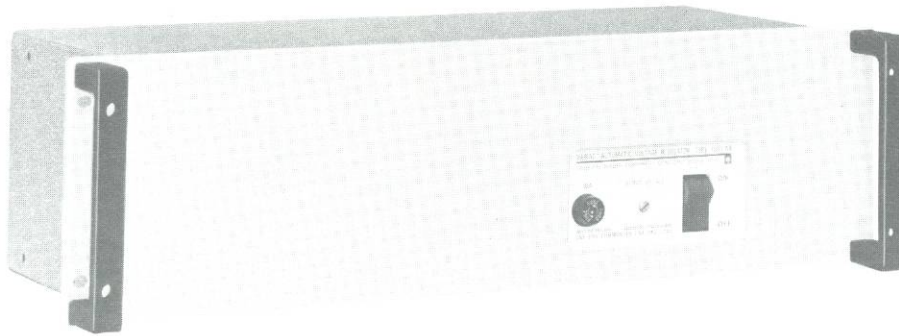

Variac® automatic voltage regulator

Type 1591

- capacity to 1 kVA
- 115-V models
- accuracy of $\pm 0.2\%$
- low-cost, compact
- portable and rack models



The small size of the 1591 particularly suits it to portable applications.

Low-cost regulation Electromechanical voltage regulators have always offered large power-handling capacity with minimum bulk and cost. These advantages are now available in a 1-kVA regulator, thanks to a special control circuit. Still, as with the larger GR regulators, there is no distortion added to the input waveform; average-voltage and peak-voltage values are therefore constant, as rms voltage is regulated. Accuracy is independent of line frequency, load current variations, and power factor.

Output voltage is controlled by a servo-driven Variac® adjustable autotransformer so the regulator has the same ability to handle 1000% transient overloads as the Variac. The 1591 is mechanically rugged and has proved itself in severe vibration and shock tests. Its typical temperature coefficient of 75 ppm/°C is so small as to be negligible under normal operating conditions.

— See **GR Experimenter** for October 1967.

SPECIFICATIONS

Principal Characteristics

Description	Type	Input		Output				
		Variation* (range)	Frequency	Voltage* (adjustable)	Current Rating	kVA	Correction Rate**	Regulation*
115 V	1591	100 to 130 V	57 to 63 Hz	105 to 125 V	8.7 A	1	6 c + 1.5 c/V	$\pm 0.2\%$

* Also see curve. Output voltage will remain within regulation with the specified input variation; e.g.: When the output is adjusted to 105 V, it will remain there within $\pm 0.2\%$ (0.21 V) with inputs from 100 to 130 V.

** Correction rate is given in terms of c cycles of the power-line frequency.

Output Characteristics: POWER FACTOR: 0 to 1, leading or lagging. RESPONSE: Rms. DISTORTION: None added. REGULATION: Regulation accuracy applies for any combination of line voltage or frequency, load current or power factor. CONTROL: Front-panel screwdriver adjustment.

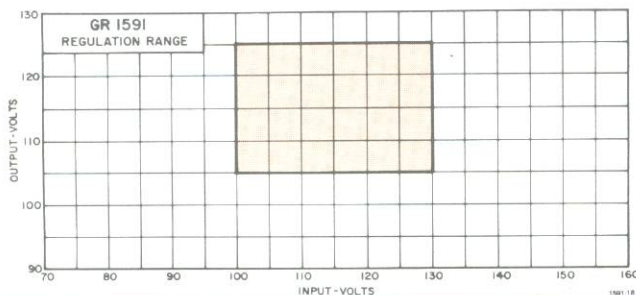

Environment: TEMPERATURE: -20 to $+40^\circ\text{C}$ for portable model, -20 to $+52^\circ\text{C}$ for rack model; operating. VIBRATION: 0.03 in. from 10 to 55 Hz. BENCH HANDLING: 4 in. or 45° (MIL-810A-VI). SHOCK: 30 g, 11 ms.

Electrical: POWER: ≈ 40 W no load, ≈ 95 W full load.

Mechanical: Portable and rack models. DIMENSIONS (wxhxd): Portable, 12.75x9.5x5.38 in. (324x241x137 mm); rack, 19x5.25x6.38 in. (483x133x162 mm). WEIGHT: Portable, 17 lb (8 kg) net, 25 lb (12 kg) shipping; rack, 22 lb (10 kg) net, 31 lb (15 kg) shipping.

Description	Catalog Number
1591 Variac® automatic voltage regulators	
115-V, 60 Hz	
1591-A, Portable Model	1591-9700
1591-AR, Rack Model	1591-9712

Variac® automatic voltage regulator

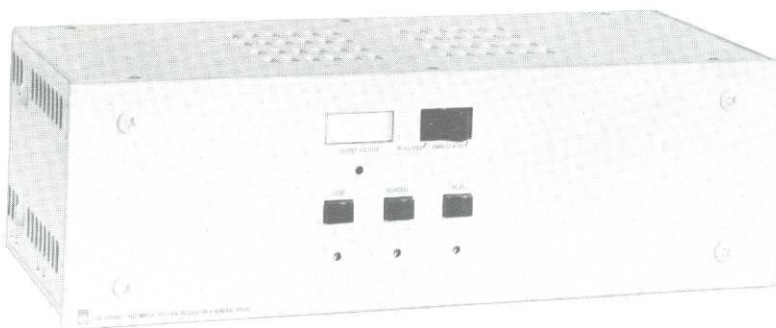

Type 1592

- capacity to 5.3 kVA
- 120-V and 230/240-V models
- accuracy to $\pm 0.25\%$
- lowest-cost regulator per kVA
- remotely programmable
- universal cabinet

Economical performance Regardless of load or line variations, the 1592 supplies the voltage necessary for the proper operation and longevity of your equipment — any equipment from light bulbs to computers — because the regulator adds no distortion and operates independently of power factor.

It is virtually unaffected by temperature, is very fast responding, and is so efficiently engineered and built that only two basic models handle all requirements for

120- to 480-volt, single or multi-phase systems and bench, rack, or wall-mount installations. It is also a versatile test instrument; the output can be programmed manually by means of front-panel pushbuttons, for any sequence of three preset voltages, or remotely with infinite resolution.

Since the 1592 is an electro-mechanical regulator, it provides tight regulation accuracy without regard to line frequency, load variations, or power factor. Its output is controlled by a servo-driven Variac® adjustable autotransformer with a long history of engineering refinements and an ability to handle 1000% transient overloads. The control circuitry is ultra simple and exceptionally reliable due to a unique concept introduced by GR and field-proven (including severe shock and vibration tests) for many years. This circuitry also allows the output voltage to be remotely sensed and controlled.

— See **GR Experimenter** for July/September 1970.

SPECIFICATIONS

Principal Characteristics:

Description	Input		Voltage* (adjustable)	Current Rating	Output		
	Variation* (% of output)	Frequency (Hz)			kVA	Correction Rate**	Regulation*
120 V $\pm 10\%$	$\pm 10\%^{***}$	60†	90 to 130 V***	44 A	5.3	25 ms/V	$\pm 0.3\%$
120 V $\pm 20\%$	$\pm 20\%^{***}$	60†	90 to 130 V***	20 A	2.4	13	$\pm 0.5\%$
230/240 V $\pm 5\%$	$\pm 5\%^{\dagger\dagger}$	50 to 60	180 to 260 V††	42 A	10.	50 ms/V	$\pm 0.25\%$
230/240 V $\pm 10\%$	$\pm 10\%^{\dagger\dagger}$	50 to 60	180 to 260 V††	18 A	4.3	25	$\pm 0.3\%$
230/240V $\pm 20\%$	$\pm 20\%^{\dagger\dagger}$	50 to 60	180 to 260 V; †	8.5 A	2.	13	$\pm 0.5\%$

* Also see curve. Output voltage will remain within regulation with any specified input variation; e.g.: When the output of the 120-V $\pm 10\%$ model is adjusted to 90 V, it will remain within $\pm 0.3\%$ (0.27 V) of 90 V with inputs of $\pm 10\%$ of 90 V (81 to 99 V).

** Correction is slow speed at 60-Hz operation.

† Can be operated at 50 Hz if output is limited to 115 V.

*** Can be increased to 138 V (for use in 240-V, 3-phase, 4-wire systems) with 9 and 18% input variations, respectively.

†† Can be increased to 277 V (for use in 60-Hz, 480-V, 3-phase, 4-wire systems) with 5, 9, and 18% input variations, respectively.

Output Characteristics: POWER FACTOR: 0 to 1, leading or lagging. RESPONSE: Rms. DISTORTION: None added. REGULATION: Regulation accuracy applies for any combination of line voltage or frequency, load current or power factor. CONTROL: Output can be rapidly switched among 3 levels by front-panel pushbuttons, each level independently adjustable by front-panel screwdriver controls or, for remote-control applications, by external resistors connected to rear by push-on terminals; TTL programming of level change available. Voltage can also be sensed remotely by 2 leads connected to rear by push-on terminals; use these to ensure desired voltage at the load and compensation for wiring IR drop. RANGE OF

OUTPUT LEVELS V_o , for specified regulation: See curves. Examples: $\pm 20\%$ model, $90 < V_o < 130$ V for input variation of 104 to 108 V; $100 < V_o < 120$ V for 96 to 120 V; $\pm 5\%$ model, $113 < V_o < 117$ V for 112-to-118 V input variation.

Meter: Front-panel pushbutton permits meter to read input or output. RANGE: 80 to 160 V (160 to 320 V). ACCURACY: $\pm 2\%$ at nominal 120/240-V reading; tracking accuracy, $\pm 5\%$.

Electrical: There are two basic models, 120-V and 230/240-V input, whose only major differences are the meter and Variac adjustable autotransformer. The various versions of each model are achieved by internal wiring changes that can be effected simply in the field if desired. POWER: ≈ 45 W no load, ≈ 120 W full load.

Mechanical: Bench, rack, and wall mount (brackets, handles, and hardware supplied for conversion). DIMENSIONS (wxhxd): 17x5.25x11 in. (432x133x279 mm). WEIGHT: 42 lb (20 kg) net, 56 lb (26 kg) shipping.

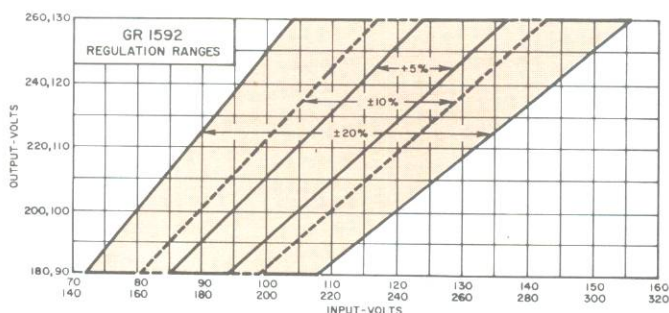

Description	Catalog Number
1592 Variac® automatic voltage regulator	
120-V $\pm 10\%$ Model	1592-9700
120-V $\pm 20\%$ Model	1592-9701
230/240-V $\pm 5\%$ Model	1592-9702
230/240-V $\pm 10\%$ Model	1592-9703
230/240-V $\pm 20\%$ Model	1592-9704

TTL-Programmable Models, on request

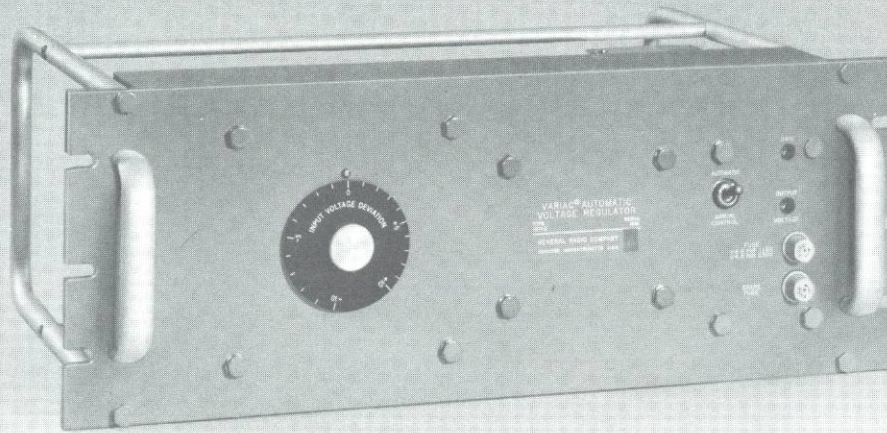

Variac® automatic voltage regulator

Type 1571

- capacity to 5.8 kVA
- 115-V models
- accuracy to $\pm 0.25\%$
- militarized
- rack models

MIL specifications The 1571 regulators are essentially versions of the 1581 which are designed to meet the appropriate sections of military specifications MIL-E-4158B

SPECIFICATIONS

Principal Characteristics:

Description	Type	Input		Output				
		Variation* (% of output)	Frequency (Hz)	Voltage* (adjustable)	Current Rating	kVA	Correction Rate**	Regulation*
115 V $\pm 10\%$, 60 Hz	1571-AL	$\pm 10\%$	57 to 63†	103 to 127	50 A	5.8	2.5 c + 1.5 c/V	$\pm 0.25\%$
115 V +24 -18%, 60 Hz	1571-AL2	+24 -18%	57 to 63†	103 to 127	25 A	2.9	2.5 c + 0.7 c/V	$\pm 0.5\%$
115 V $\pm 10\%$, 400 Hz	1571-ALJ	$\pm 10\%$	350 to 450	103 to 127	50 A	5.8	17.5 c + 10.5 c/V	$\pm 0.25\%$
115 V +24 -18%, 400 Hz	1571-AL2J	+24 -18%	350 to 450	103 to 127	25 A	2.9	17.5 c + 4.9 c/V	$\pm 0.5\%$

* Also see curve. Output voltage will remain within regulation with the specified input variation; e.g.: When the output of the model in the first row is adjusted to 103 V, it will remain there within $\pm 0.25\%$ (0.26 V) with inputs of 103 V $\pm 10\%$ (93 to 113 V).

** Correction rate is given in cycles of line frequency, c.

† Will operate from 48 to 63 Hz with internal wiring change that incidentally reduces variation by about 1/10, i.e., to $\pm 9\%$, and +19 -16%.

Output Characteristics: POWER FACTOR: 0 to 1, leading or lagging. RESPONSE: Rms. DISTORTION: None added. CONTROL: Front-panel screwdriver adjustment. REGULA-

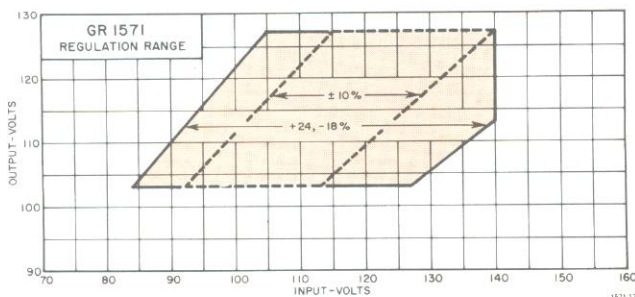

and MIL-E-16400C. These rugged models are particularly useful where mechanical shock or vibration is encountered. We offer models for nominal power-line frequencies of 400 Hz and others for 60 Hz (adaptable by reconnection for either 60 Hz or 50-to-60 Hz). You have a further choice of output current ratings and correction ranges.

The regulator comprises a motor-driven Variac® adjustable autotransformer, an auxiliary step-down transformer that multiplies the power rating of the autotransformer, and a solid-state control unit that automatically positions the autotransformer to hold the rms output voltage constant. The true proportional control system provides both fast correction and smooth control.

REGULATION: Regulation accuracy applies for any combination of line voltage or frequency, load current or power factor.

Environment: Appropriate sections of MIL-E-4158B and MIL-E-16400C. TEMPERATURE: -29 to +52°C operating, -54 to +85°C storage.

Electrical: POWER: ≈ 35 W no load, ≈ 115 W full load.

Mechanical: Rack models. DIMENSIONS (wxhxd): 19x7x12 in. (483x178x305 mm). WEIGHT: 53 lb (25 kg) net, 103 lb (47 kg) shipping.

Description Catalog Number

1571 Variac® automatic voltage regulators

115-V Models

1571-AL, $\pm 10\%$, 60 Hz	◆	1571-9831
1571-AL2, +24 -18%, 60 Hz	◆	1571-9898
1571-ALJ, $\pm 10\%$, 400 Hz		1571-9551
1571-AL2J, +24 -18%, 400 Hz		1571-9556

◆ Federal stock numbers are listed before the Index.

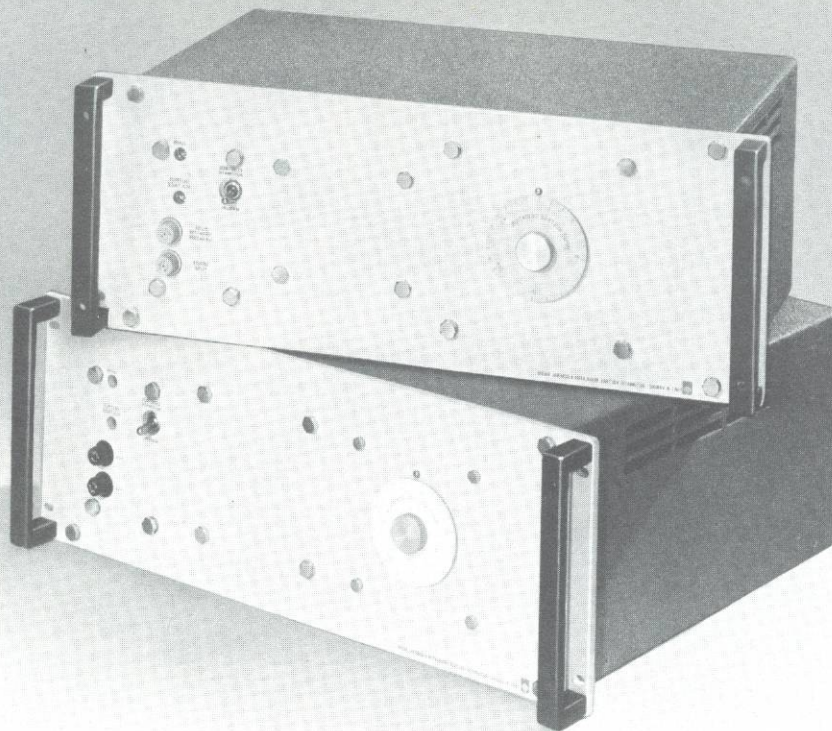

Variac[®] automatic voltage regulators

Types 1581 and 1582

- capacity to 19.7 kVA
- 115-V, 230-V and 460-V models
- accuracy to $\pm 0.25\%$
- highest-capacity GR regulators
- wall, bench, and rack models

High capacity, low cost The 1581 and 1582 all-solid-state regulators automatically compensate for ac line-voltage fluctuations to provide a reliable constant-voltage source over a wide correction range. The true propor-

tional control system provides both fast correction and smooth control.

These regulators give you high accuracy with large capacity for both laboratory and industrial installation. They are especially useful for computers, measurement systems, transmitter supplies, and critical industrial processes.

A large variety of models provides you a choice of 115-, 230-, or 460-V operation on 50-, 60-, or 400-Hz lines with loads up to 19.7 kVA; models are available for wall, rack, or bench use. The units are described as single-phase regulators but they can regulate three-phase lines. For example, two regulators can be used in an open-delta configuration and three can be used in wye or closed-delta configurations.

SPECIFICATIONS

Principal Characteristics:

Description	Type	Input		Voltage* (adjustable)	Current Rating	Output		
		Variation* (% of output)	Frequency** (Hz)			kVA	Correction Rate†	Regulation*
115 V $\pm 10\%$, 50 A	1581-AL	$\pm 10\%$	57 to 63	103 to 127 V	50 A	5.8	2.5 c + 1.5 c/V	$\pm 0.25\%$
115 V $\pm 10\%$, 85 A	1582-AL	$\pm 10\%$	57 to 63	103 to 127 V	85 A	9.8	2.5 c + 3 c/V	$\pm 0.25\%$
115 V +24 -18%, 25 A	1581-AL2	+24 -18%	57 to 63	103 to 127 V	25 A	2.9	2.5 c + 0.7 c/V	$\pm 0.5\%$
115 V +24 -18%, 42.5 A	1582-AL2	+24 -18%	57 to 63	103 to 127 V	42.5 A	4.9	2.5 c + 1.5 c/V	$\pm 0.5\%$
230 V $\pm 5\%$, 40 A	1581-AH5	$\pm 5\%$	57 to 63	206 to 254 V	40 A	9.2	2.5 c + 1.5 c/V	$\pm 0.25\%$
230 V $\pm 5\%$, 85 A	1582-AH5	$\pm 5\%$	57 to 63	206 to 254 V	85 A	19.7	2.5 c + 3 c/V	$\pm 0.25\%$
230 V $\pm 10\%$, 20 A	1581-AH	$\pm 10\%$	57 to 63	206 to 254 V	20 A	4.6	2.5 c + 0.7 c/V	$\pm 0.25\%$
230 V $\pm 10\%$, 42.5 A	1582-AH	$\pm 10\%$	57 to 63	206 to 254 V	42.5 A	9.8	2.5 c + 1.5 c/V	$\pm 0.25\%$
230 V +24 -18%, 10 A	1581-AH2	+24 -18%	57 to 63	206 to 254 V	10 A	2.3	2.5 c + 0.4 c/V	$\pm 0.5\%$
230 V +24 -18%, 21.3 A	1582-AH2	+24 -18%	57 to 63	206 to 254 V	21.3 A	4.9	2.5 c + 0.7 c/V	$\pm 0.5\%$
460 V $\pm 5\%$, 34 A	1582-AK5	$\pm 5\%$	57 to 63	412 to 508 V	34 A	15.6	2.5 c + 1.5 c/V	$\pm 0.25\%$
460 V $\pm 10\%$, 17 A	1582-AK	$\pm 10\%$	57 to 63	412 to 508 V	17 A	7.8	2.5 c + 0.7 c/V	$\pm 0.25\%$
460 V +24 -18%, 8.5 A	1582-AK2	+24 -18%	57 to 63	412 to 508 V	8.5 A	3.9	2.5 c + 0.4 c/V	$\pm 0.5\%$

* Also see curve. Output voltage will remain within regulation with the specified input variation; e.g.: When the output of the model in the first row is adjusted to 108 V, it will remain there within $\pm 0.25\%$ (0.27 V) with inputs of 108 V $\pm 10\%$ (97 to 119 V).

† Correction rate is given in c cycles of the line frequency. With the 400-Hz option, correction time is about the same, so multiply the tabulated rate by 7.

** Will operate from 48 to 63 Hz with internal wiring change that incidentally reduces variation by about 1/10 (to 5%, 9%, +19 - 16%). With 400-Hz option, will operate from 350 to 450 Hz.

Output Characteristics: POWER FACTOR: 0 to 1, leading or lagging. RESPONSE: Rms. DISTORTION: None added. CONTROL: Front-panel screwdriver adjustment. REGULATION: Regulation accuracy applies for any combination of line voltage or frequency, load current or power factor.

Environment: TEMPERATURE: -20 to +52°C operating; -54 to +85°C storage.

Electrical: POWER: 1581: ≈ 35 W no load, ≈ 115 W full load. 1582: ≈ 45 W no load, ≈ 120 W full load.

Mechanical: Bench, rack, or wall mount. 1581: DIMENSIONS: 19x7x10.5 in. (483x178x267 mm); for cabinet add 2 in. (51 mm) to depth. WEIGHT: 42 lb (19 kg) net, 92 lb (42 kg) shipping; for cabinet add 6 lb (3 kg) to net and 12 lb (6 kg) to shipping. 1582: DIMENSIONS: 19x7x14.25 in. (483x178x362 mm); for cabinet add 2 in. (51 mm) to depth. WEIGHT: 61 lb (28 kg) net, 110 lb (50 kg) shipping; for cabinet add 15 lb (7 kg) to net and 16 lb (8 kg) to shipping.

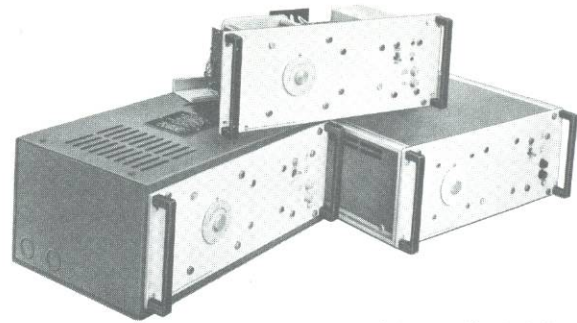
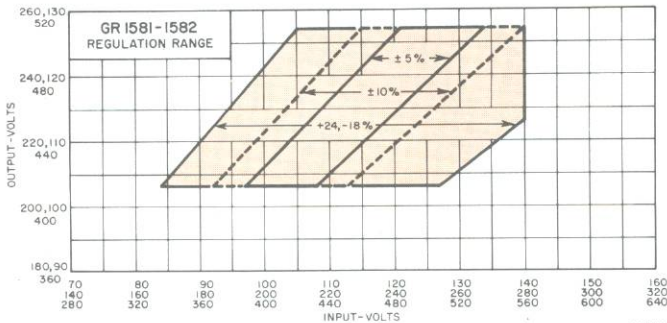

Your choice of regulator enclosures: Top, without cabinet; left, wall-mountable cabinet; right, convertible to either bench or rack-mounted use.

Description

Catalog Number

Variac® automatic voltage regulators

(Unless options are specified, all come for line frequency 60 Hz, without cabinets)

115-V Models

- 1581-AL, ±10%, 50 A
- 1582-AL, ±10%, 85 A
- 1581-AL2, +24 -18%, 25 A
- 1582-AL2, +24 -18%, 42.5 A

230-V Models

- 1581-AH5, ±5%, 40 A
- 1582-AH5, ±5%, 85 A
- 1581-AH, ±10%, 20 A
- 1582-AH, ±10%, 42.5 A
- 1581-AH2, +24 -18%, 10 A
- 1582-AH2, +24 -18%, 21.3 A

460-V Models

- 1582-AK5, ±5%, 34 A
- 1582-AK, ±10%, 17 A
- 1582-AK2, +24 -18%, 8.5 A

Select the following options, as desired

- OP1 Bench Cabinet
- OP2 Rack Cabinet
- OP3 Wall Cabinet
- OP4 400-Hz Line Frequency

(Describe exactly as shown at the left.)

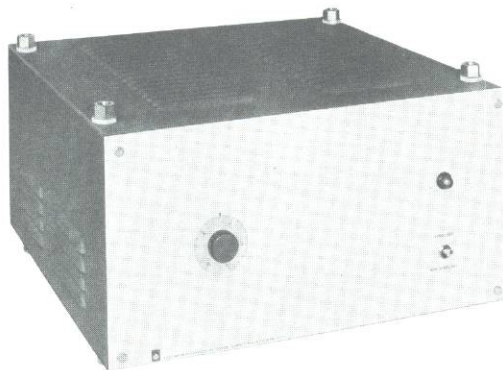

Variac® automatic voltage regulators

Type 1585

- 1% output accuracy
- high power — up to 300 kVA 3-phase
- distortion-free regulation
- any load power factor
- transient overloads up to 1000%

The 1585 series of automatic voltage regulators, described only briefly here, is particularly appropriate for customers in Europe, or those who can readily import from Europe. These regulators, like the 1581 and 1582 models, for example, feature the efficiency and voltage-waveform preservation of transformer coupling from the power line to your load, with the turns ratio continuously and automatically adjusted to maintain the constant rms terminal voltage you select.

A large number of standard versions are readily available; specials also upon request. Standard features include single- or three-phase networks, standard power-line voltages and frequencies, mountings (presentation) of three kinds — portable, rack-or-bench, and housed in a stackable metal cabinet. Models are available with voltmeters.

— Note: This product is manufactured only in Europe.

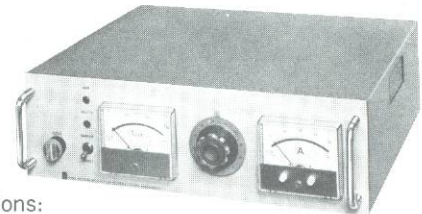

SPECIFICATIONS

— for standard versions:

Power: Up to 300 kVA (3-phase).

Frequency: 48 to 63 Hz.

Output Voltage: Adjustable over a range of ±10% from a nominal 127 or 220 V, single phase, set by a front-panel screwdriver control. RESPONSE: Rms. DISTORTION: None added by the regulator.

Variac® adjustable autotransformers

What is a Variac?

Applications

How to Select a Variac

New — the U2

General Specifications

Single-Phase Models

Three-Phase Models

400-Hz Models

Portable Models

Motor-Driven Versions

Basic Data for Single Sections

Get More Out of Your Variac



Variac® Adjustable Autotransformer

What Is a Variac?

The Variac® autotransformer is an efficient, trouble-free device for controlling ac voltage and any other quantities that derive from ac voltage: heat output, light intensity, motor speed, and the outputs of various power supplies. The name Variac comes from the unit's function — “vary ac” — and is General Radio's registered name for its continuously adjustable autotransformer.

Unlike most transformers, the Variac has a transformation ratio that can be smoothly and continuously changed so the output of the unit can be controlled from zero to line voltage or even higher. Because it is a transformer, the Variac is

- **efficient** transforms power more efficiently than rheostats
- **durable** because it runs cool
- **overload-able** withstands 1000% short-term overloads
- **independent of load size or power factor** voltage to the load changes little from full load to none

Applications

In most applications, a full turn of the Variac control shaft (320°) varies the output voltage, applied to the load, from zero to line voltage or 17% above if connected for “overvoltage” operation. Thus, the light or heat output or speed or torque of the load is varied from zero to rated or above. Some typical applications are shown below.

Voltage doubling If the available line voltage is only about half that required by the load, the Variac can double the voltage while providing full control of the output. Units designated by an “H” (W20H) are supplied with an input connection for this use; output current rating of the transformer is one-half its normal value in this case. On special order, similar connections for other multiplying ratios can be supplied.

Other applications The Variac autotransformer can also be used as a phase-shifter in three-phase circuits, as a color-temperature control, for calibrating voltmeters, ammeters, and wattmeters, and in many unique applications. It is the basis of a wide line of General Radio automatic line-voltage regulators and can be used in many similar custom applications.

Special models General Radio welcomes inquiries concerning special models. We can, for example, modify taps, include limit switches, change shaft length, add ball

- **quiet** adds no noise or distortion to the line
- **reliable** exclusive Duratrak® contact surface prevents injurious high-temperature oxidation and resultant brush-track deterioration

In addition, the Variac is

- **easy to install.** All mounting hardware is included; wiring diagram is on the terminal plate; conduit knockouts are included on all enclosed models.
- **available in hundreds of standard versions** to satisfy line frequency, voltage, and phase requirements, load size, mounting demands (including portable and metered models). They can be supplied with motor drives, ball bearings, and in ganged assemblies to increase basic line-voltage and load-current ratings.
- **assured safe** by Underwriters' Laboratory listing and Canadian Standards approval of many models
- available in militarized models specifically designed for 400-Hz operation

bearings, provide for 360° mechanical rotation, add one or more independently controlled brushes, treat the units with fungicide or otherwise prepare them for use in abnormal environments.

Typical Applications for Variac® autotransformers

Type of Load	Function Controlled
Incandescent Lamps	Brilliance and color temperature
Fluorescent Lamps (both hot- and cold-cathode types)	Brilliance (special circuitry required for best results)
Heating Devices (resistive heaters and infra-red lamps)	Temperature
Motors	
AC Motors	
Universal Series	} Use only on fan loads, or where torque is proportional to speed
Repulsion	
Two-phase	
Shaded-pole	
Split-phase induction	
Capacitor split phase	
DC Motors	Use with rectifier for motor-speed control
Rectifiers	
Electroplating	Current
Power and plate circuits	Voltage
Solenoids	Force
Test Loads	High and low line-voltage testing, breakdown tests

How to Select a Variac

The Variac® adjustable autotransformers are grouped by line frequency, voltage, and phase, with brief specifications for each model.* Within each group, the units are listed in order of increasing load rating that can be expressed in either current (amperes) or power (kVA). To make the selection you must know the line and load characteristics for your application. A brief look at these quantities may help.

Line frequency Most Variac models in the "W" series are designated for 50-to-60 Hz operation ("L" models are for 60 Hz only). Some "W" models can be used, without being derated, up to at least 400 Hz, but the regulation will be greater than normal and the physical size and weight larger than necessary. Therefore, we offer the "M" series Variac that is designed for operation from 350 to 1200 Hz. The M-series units are smaller and have better regulation at the higher frequencies. When series connected or when ordered specially, these units will also operate from 240-V lines.

Phase Variac models are available for both single- and three-phase operation. In general, three-phase ratings are governed by the ratings of each individual transformer in the assembly. That is, the voltage applied to, or the current drawn from, each individual unit must not exceed that specified for its single-phase uses. Thus, the considerations discussed below for single-phase applications apply separately to each unit in a three-phase assembly. A more detailed discussion on three-phase ratings and how to calculate them is given later in this section.

Line voltage Single-phase lines are normally either 120-volt or 240-volt, and GR Variac models come in two basic families to match. Should your line voltage be less than nominal, a unit rated for the nominal value will operate perfectly with no derating in current. Line voltage up to 17% above the nominal can be applied if overvoltage output is not required. For example, up to 140 volts line voltage can be applied to nominal 120-volt models if the maximum output voltage required is no more than the line voltage applied.

For single-phase line voltages from 480 to 560 volts, two Variac units rated for 240-V operation must be used with their coils connected in series across the line and the load connected one side to each of the Variac outputs. For such use, the load cannot be grounded at any point.

Load rating The load capacity of GR Variac autotransformers is specified in three ways: maximum current, rated current in amperes, and power in kVA (kilovolt-amperes). Although closely related, they are different and the differences are important to the proper selection of your Variac.

An autotransformer cannot supply as much current at midrange settings as it can at full-voltage setting without overheating. Yet some nonlinear loads, incandescent lights for example, may draw nearly as much current at

half voltage as they do at rated voltage, while other (linear) loads will draw current proportional to the applied voltage. As a general rule, if the load is nonlinear, or if the overvoltage connection is used to apply more than line voltage to the load, a Variac should be chosen that has a Rated Current adequate for the load. Otherwise, the larger Maximum Current is the load-rating limit. Special applications may permit higher current to be drawn; for a more complete discussion of ratings, see "Get More Out of Your Variac," later in this section.

The Variac power rating in kVA is given as a convenience in matching the right Variac to the load. It is the product of the rated line voltage and the *maximum* current rating of the Variac. There is a risk of misinterpreting it and exceeding the limits mentioned above; the kVA rating can be used only if the load is linear and the overvoltage connection is *not* used. Otherwise, load current must be determined and a Variac selected that has adequate rating.

Power ratings in kVA are given for three-phase Variac applications and must be interpreted as described above.

Trade-offs While some trade-offs, like those mentioned above, are included in the selection tables, there are others you may wish to consider. The load-current capacity of the Variac is limited by temperature and life. Specified ratings assume a maximum ambient temperature of 50°C and a minimum life span of 7 years. If the expected ambient is lower or forced cooling is possible, the autotransformer can be uprated without affecting life. Also, if a shortened life is not a problem in your application, a further uprating can be realized.

Finally, if the load is expected to be switched on and off regularly (as with a thermostatically-controlled heater), the Variac can be uprated. In general, if the time for an on-off cycle is 2 hours or less and the off time is 10% or more of the total cycle time, some significant improvement in rating can be realized.

Calculations and curves for duty-cycle and temperature are given in detail later in this section.

Selecting the proper Variac Autotransformer Knowledge of the line frequency, voltage, and phase of your application will lead you to one of several tables that follow. The considerations above will have helped you determine the current or power that the Variac must be capable of handling. Now, merely scan down the left columns in the table ("Rated Current," "Maximum Current," or "kVA") until you find an entry that equals or exceeds the value determined by your load. It may be rewarding to consider several models, including those with slightly higher ratings than necessary, as there is the possibility of saving money, space, or both. Some models (designated "L" as in W5L) offer higher ratings per dollar and have only the minor restrictions of 60-Hz operation only and no overvoltage connection.

Parallel connections In some instances, the selection tables will indicate that the ganged assembly you have chosen requires parallel connection of the individual

* Models made in Europe are not described here.

units. Reference is made to a Type W50-P1 Choke, which *must* be used between the output connections of the individual units in the assembly to prevent one unit from forcing current into another, possibly causing excessive temperature and early failure. One choke is needed if two units are to be paralleled; three or more parallel units require one choke for each Variac. The chokes are *not* included with the ganged assembly and must be ordered separately (except for 9- and 12-gang W50 and W50H units which are shipped *with* chokes).

How to order When you have chosen the right Variac autotransformer from the selection tables, record the 8-digit catalog number and type number. Your order should include this information and a complete description of the unit. This permits us to cross-check your order and catch any typographic errors.

Note that there are no 8-digit numbers given for motor-driven or ball-bearing models; ordering should be done by a constructed type number (see below) and full description.

Models shown in the following lists may be ordered from GR at Concord, Massachusetts or your appropriate Regional Center or sales representative; refer to the front of the catalog. Of course, any of these offices will gladly assist you in selecting a standard Variac autotransformer or considering a special design to match your exact needs.

Made in Europe Many customers will undoubtedly want to obtain catalog information on the Variac product line made in Europe. Please direct your inquiries to General Radio (Overseas); the address is given in the front of the catalog.

Type Number Terminology

In their various combinations, type numbers for Variac autotransformers consist of letters and numerals that indicate exactly what elements are included in each assembly. The following examples show the various combinations:

M	350-to-1200 Hz operation
W	50-to-60 Hz operation
W5	Model size, 120 V input
W5H	240-V input
W5L	60-Hz only, no overvoltage
W5HG2	2-gang W5H (substitute 3 for 3-gang, etc)
W5HG2BB	Adds ball bearings
W5HG2BBM	Adds complete enclosure
W5HG2D4CK	D indicates motor drive; 2, 4, 8, 16, 32, 64, or 128 following D indicates number of seconds for full traverse. C indicates phase-splitter capacitor and K indicates limit switches. Omit BB from motor-drive type numbers since motor-driven units are always equipped with ball bearings.
W5MT	Portable units with 2-wire line cord
W5MT3	With 3-wire line cord
W5MT3VM	With voltmeter
W5MT3A	With voltmeter and ammeter
W5MT3W	With voltmeter and wattmeter
W5MT3AW	With voltmeter, ammeter and wattmeter

Variac® adjustable autotransformer—U2

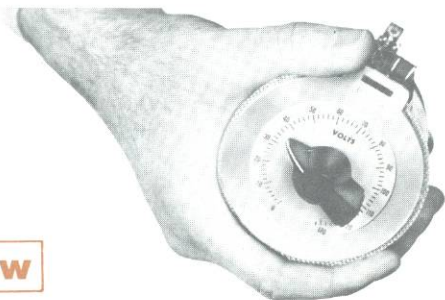

New

Low-cost versatility The U2, a new low-cost adjustable autotransformer from GR, features simplified mounting for a variety of low-current control applications. It can be used with any input up to 120 volts, 60 to 400 Hz, and provides a full 140-volt output with a 120-volt input.

A single nut secures the autotransformer to any panel up to ¼-inch thick. The unit's small size allows it to be used on densely packed front-panel configurations — the U2 is a natural for low-current applications in almost any situation.

- lowest cost 2-A unit available
- highest voltage output — up to 140 V
- oversize brush and cooler operation assure extended life
- easily replaced shaft for special applications

SPECIFICATIONS

Input: 120 V, 60 to 400 Hz.

Output:	In Air		On Aluminum Panel	
	0 to 120 V:	2 A rated	2.25 A max	2.25 A rated
0 to 140 V:	2 A rated	2 A max	2.25 A rated	2.25 A max

Mechanical: Single-hole mounting of 0.375 in. (10 mm) for shaft plus 0.1875-in. (5-mm) hole for anti-rotation stop, max panel thickness 0.25-in. (6 mm). **DIMENSIONS** (wxhxd depth behind panel) 3.25x3.69x2.94 in. (83x94x75 mm). **WEIGHT:** 2.5 lb (1.2 kg) net, 3 lb (1.4 kg) shipping.

Description	Catalog Number
U2 Variac® adjustable autotransformer	3200-5110

General Specifications

Ball Bearings Ball bearings at both ends of the shaft are offered for all units. They are useful where more precise alignment, more constant torque, and longer life are required. Ball bearings are standard on all motor-driven Variac® autotransformers, and on all 4- to 12-gang types W30, W30H, W50, and W50H manually-operated models.

Connections, Output "Line-voltage connection" refers to the connection of the Variac autotransformer for an output-voltage range of zero to line voltage. "Overvoltage connection" refers to the input-voltage connection for a range of output voltage from 0 to 117% of line voltage.

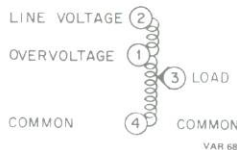

Current, Maximum Maximum current can be drawn at maximum voltage only when the line-voltage connection is used.

Current, Rated This current can be drawn at any dial setting, independent of overvoltage or line-voltage connection.

Dial Dial plates for single units are reversible. They read 0 to 120 volts output on one side and 0 to 140 volts on the other. H models have similar scale readings of 0 to 240 and 0 to 280. Dial plates are calibrated for mounting on a panel or on the front of a case; output voltage increases with clockwise rotation of the knob. All ganged assemblies are supplied with dials calibrated on one side only, reading 0 to 10.

Frequency, Line W-series units are specified for 50-to-60 Hz service except for the L types which are for 60-Hz service only.

However, both of these units can be operated at rated values at line frequencies to 400 Hz. For 350-to-1200 Hz service the M-series units are preferred. Models intended for 240-volt, 60-Hz service can be used at 25 Hz at their normal current rating but at one-half their 60-Hz voltage rating.

kVA Ratings The kVA rating is the maximum load current multiplied by the nominal input line voltage.

Resolution Variac resolution is virtually infinite as the resistive brush always spans 2 or more turns of the autotransformer winding.

Motor-Driven Units All Variac autotransformers, both single and ganged units, can be furnished with motor drive.

Mounting Hardware All models are supplied with the necessary mounting hardware.

Special Designs We welcome requests for modifications of any model. These include different windings, shifting taps, different shafts, or basic new designs to furnish output voltages or voltage ranges differing from standard models. On special order, all W-series Variac autotransformers can be manufactured to conform to military requirements that are standard with the M-series units.

Temperature Rise Ratings are based upon operation at ambient temperatures of up to 50°C. When the ambient temperature exceeds this figure, current ratings should be decreased (see Figure 2).

Terminals All models have combined soldering and screw-type terminals with the exception of the types W30 and W50 which are equipped with clamping terminals. Models for 120-volt lines have five terminals for either 120- or 140-volt maximum output connections: 240-volt units have two extra terminals to provide for either 120- or 240-volt input for 280-volt output.

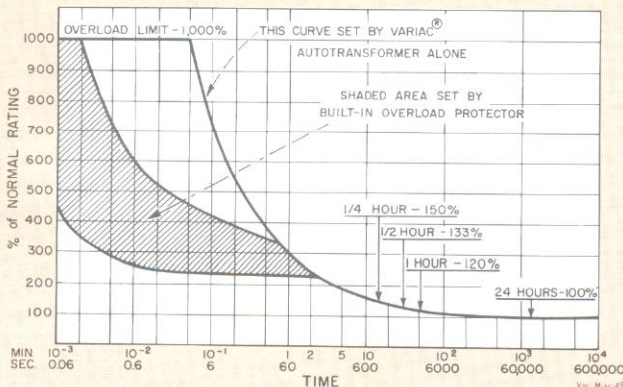

Figure 1. Short-time overload characteristic of Variac autotransformers with line-voltage connection.

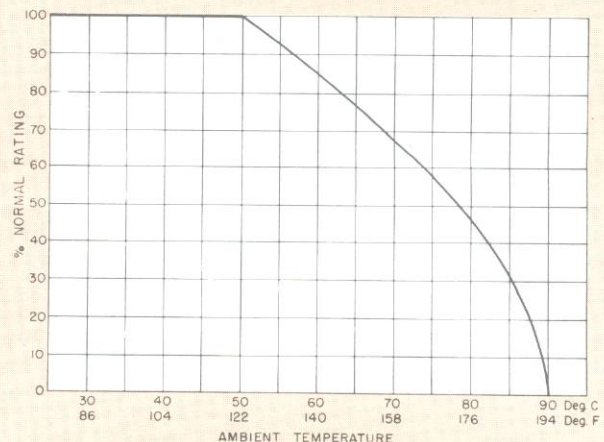

Figure 2. Variac autotransformer derating versus ambient temperature.

General Specifications (Cont'd)

Military Environmental Specifications Most Variac autotransformers have been tested and do meet some or all of the following Military Specifications: MIL-STD-202, MIL-STD-810, MIL-STD-167, MIL-E-4158, MIL-E-4970, MIL-E-5272, MIL-E-5400, MIL-E-16400, MIL-R-23098, MIL-S-901C, MIL-T-945, and MIL-T-5422. "Certification of Compliance" can be furnished at no charge for units tested. Copies of the test data are also available for a small fee. For further information on environmental tests, please contact your local GR District Office.

Overload Protection Today's improved core materials permit the use of higher flux densities than were formerly practical. Under certain conditions of core magnetization and line-voltage phase, an inrush transient or surge having an initial value up to ten times the rated current of the unit may occur. This does no harm except to ordinary "quick-blow" fuses. For this reason, time-current integrating circuit breakers or "slow-blow" fuses are recommended for primary protection. They will hold during transients but will protect against sustained and potentially damaging overloads. Such a protective device on the *input* side of the Variac should be capable of handling a 1000% overload for the duration of one cycle of the power-line frequency.

Overload protection for variable-ratio transformers differs from that used with fixed-ratio transformers, where safe primary and secondary currents are determined by the ratio of secondary to primary turns. For example, in a fixed-ratio transformer having 100 primary turns and 20 secondary turns, if the safe secondary current is 10 amperes, the safe primary current will be 2 amperes. Equal protection will be provided by a 10-ampere secondary fuse or a 2-ampere primary fuse.

This is not true with Variac autotransformers. As the brush traverses the winding, the transformation ratio continually changes. Under the conditions of a varying transformation ratio, primary protection is of little or no value, but output protection is all important; *it is the output current that must be held within safe limits.* For this reason a Variac autotransformer should be protected by a fuse or circuit breaker in the brush lead, where the load is normally connected.

The nature of the protective devices selected should be partially determined by the service requirements. Variac autotransformers have an inherently high short-time overload capacity because temperature is dependent upon time for a given rise. They can safely absorb relatively infrequent short-time overloads (due to motor starting or lamp inrush) without being derated.

The upper curve in Figure 1 applies to units without built-in fuse protection. Models with built-in protection in the brush arm (models W5L, W20H, W30, W30H, W50, and W50H) have overload characteristics corresponding to the shaded area on the curve. The fuse is purposely made inaccessible to guard against careless replacement with fuses of wrong value. Its basic purpose is to provide thermal protection to the autotransformer, and it is not intended to serve as the sole protective device for the unit. It is essential that the user add ex-

ternal overload protection to the output of the variac, that is, between the brush and the load.

To benefit fully from the short-term overload characteristic, the overload capacity must not be unduly limited by the protective device. Since quick-blow fuses cannot withstand surges, their use is discouraged except for loads not subject to inrush. Slow-blow fuses are better; time-current integrating circuit breakers are better still. Thermal breakers are to be preferred, since they automatically derate with increasing ambient temperature. They most nearly conform to the requirements shown in Figure 2. This type of protector is standard in the Type MT (portable, cased) models of the W-series Variac autotransformers.

Regulation Regulation is defined as the change in output voltage from no load to full load current (varying load resistance), with constant input voltage, and is expressed as a percentage of line voltage.

In an autotransformer, regulation varies with dial setting, largely because of IR drop in the winding, and is minimum at transformation ratios of zero and one. Note that, at zero and line-voltage settings, there is some slight regulation attributable to the resistance of the brush. Regulation is also due in part to leakage reactance caused by stray flux that does not link all the turns. While this is a minor factor at low frequencies, it becomes dominant at some higher frequency and actually imposes an upper-frequency limit on the operation of the autotransformer. This limit depends on the load conditions.

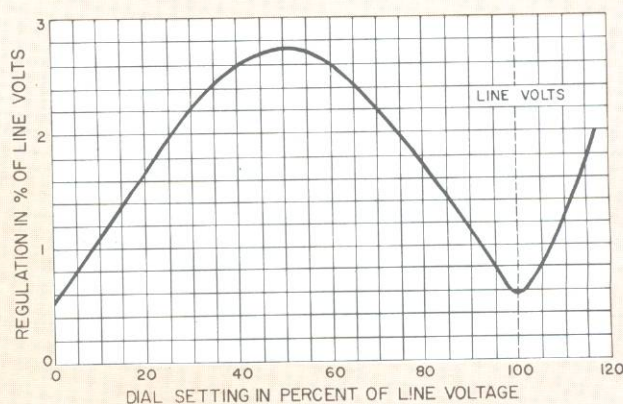

Typical regulation curve with normal rated current.

Paralleling Choke, W50-P1 Many of the Variac autotransformers listed on the following pages are indicated to require one or more Type W50-P1 Chokes (catalog number 3150-5016). This unit is used when two or more autotransformer outputs are to be connected in parallel; it impedes the flow of potentially destructive-circulating currents. Instructions for proper interconnecting are included with each unit.

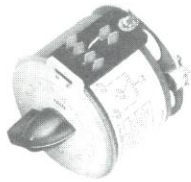

U2



W5M
(Enclosed)

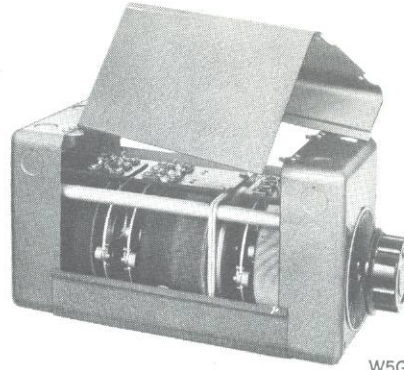

W5G3M
(3-Gang)



W5
(Open)

Single-phase, 120-volt input, 50-60 Hz

Output				Description									
Rated Current Amperes	Max. Current Amperes	kVA	Max. Output Voltage Range	Type	Mounting	Notes	W50-P1 Chokes Req'd for parallel operation	Catalog Number	Net Weight lb	Shipping Wt lb	Outline Dimensions (inches)		
											W	H	D
2.0	3.0		0-140	U2	Open			3200-5110	2.5	3	3¼	3½	2½
2.0	2.6	0.31	0-140	W2M	Encl			3010-5111	4	9	4½	5½	4½†
2.4	3.1	0.37	0-140	W2	Open			3010-5110	3	4	3¼	3½	3½†
5.0	6.5	0.78	0-140	W5M	Encl			3030-5111	7	13	4¾	6½	4¾*†
6.0	7.8	0.94	0-140	W5	Open			3030-5110	6	8	4½	4½	3½*†
7.1	9.2	1.1	0-120	W5LM	Encl	60 Hz only		3050-5111	7	13	4¾	6½	4¾
8.5	11.0	1.32	0-120	W5L	Open	60 Hz only		3050-5110	7	8	4½	4½	4½*
8.5	11.0	1.32	0-140	W8	Open			3038-5110	8	9	4½	4½	4½
10.0	13.0	1.56	0-120	W8L	Open	60 Hz only		3058-5110	8	12	4½	4½	4½
10.0	13.0	1.56	0-140	W10	Open			3060-5110	12	13	5¾	6½	3½*†
10.0	13.0	1.56	0-140	W10M	Encl			3060-5111	15	17	6¾	9½	5¼*†
14.2	18.4	2.2	0-120	W5LG2M	Encl	60 Hz only	1	3050-5121	15	23	5½	6¾	8½
17.0	22.0	2.6	0-120	W5LG2	Open	60 Hz only	1	3050-5120	14	16	4½	4½	8
17.0	22.0	2.6	0-140	W8G2	Open		1	3038-5120	16	19	4½	4½	9½
20.0	26.0	3.12	0-140	W20	Open			3090-5110	21	24	7½	8½	4½*†
20.0	26.0	3.12	0-140	W20M	Encl			3090-5111	24	29	8½	11½	5¾†
20.0	26.0	3.1	0-120	W8LG2	Open	60 Hz only	1	3058-5120	17	19	4½	4½	9½
21.3	27.6	3.3	0-120	W5LG3M	Encl	60 Hz only	3	3050-5131	22	32	5½	6¾	12¼
25.5	33.0	4.0	0-120	W5LG3	Open	60 Hz only	3	3050-5130	20	22	4½	4½	12½
25.5	33.0	4.0	0-140	W8G3	Open		3	3038-5130	25	27	4½	4½	13½
28.0	32.0	3.84	0-140	W30M	Encl			3120-5111	37	47	11	14¾	5¾
30.0	36.0	4.32	0-140	W30	Open			3120-5110	30	38	10	11½	4½
30.0	39.0	4.7	0-120	W8LG3	Open	60 Hz only	3	3058-5130	25	27	4½	4½	13½
40.0	52.0	6.2	0-140	W20G2M	Encl		1	3090-5121	48	56	9	12½	9¾
40.0	52.0	6.2	0-140	W20G2	Open		1	3090-5120	43	48	7½	8½	9¾
40.0	45.0	5.40	0-140	W50M	Encl			3150-5111	57	74	13½	16½	7¼*†
50.0	50.0	6.00	0-140	W50	Open			3150-5110	50	57	12½	13¾	6¼*†
56.0	64.0	7.7	0-140	W30G2M	Encl		1	3120-5121	67	90	11½	14½	10½
60.0	72.0	8.6	0-140	W30G2	Open		1	3120-5120	61	80	10	11½	9¾
60.0	78.0	9.4	0-140	W20G3M	Encl		3	3090-5131	71	82	9	12½	13½
60.0	78.0	9.4	0-140	W20G3	Open		3	3090-5130	65	71	7½	8½	13¾
80.0	90.0	10.8	0-140	W50G2M	Encl		1	3150-5121	123	160	13½	17½	14½
84.0	96.0	11.5	0-140	W30G3M	Encl		3	3120-5131	99	125	11½	14½	14½
90.0	108.0	13.0	0-140	W30G3	Open		3	3120-5130	93	113	10	11½	20¾
100.0	100.0	12.0	0-140	W50G2	Open		1	3150-5120	112	147	12½	13¾	14½
120.0	135.0	16.2	0-140	W50G3M	Encl		3	3150-5131	179	221	13½	17½	21½
150.0	150.0	18.0	0-140	W50G3	Open		3	3150-5130	163	206	12½	13¾	20¾
160.0	180.0	21.6	0-140	W50G4BBM	Encl		4	3150-5241	240	313	13½	17½	27¾
200.0	200.0	24.0	0-140	W50G4BB	Open		4	3150-5240	215	288	12½	13¾	27¼
240.0	270.0	32.4	0-140	W50G6BBM	Encl		6	3150-5261	355	430	13½	17½	40¾
300.0	300.0	36.0	0-140	W50G6BB	Open		6	3150-5260	325	400	12½	13¾	40

* Listed under Re-examination Service of the Underwriters' Laboratory.

† Approved by the Canadian Standards Association.

◆ Federal stock numbers are listed before the Index.

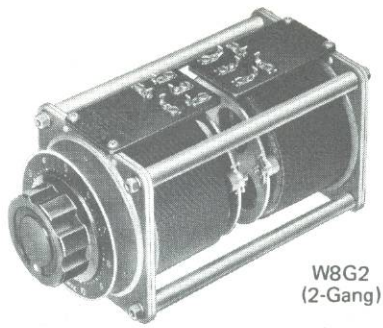

W8G2
(2-Gang)

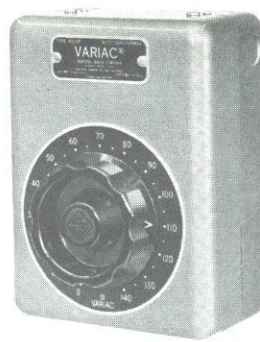

W20M
(Enclosed)

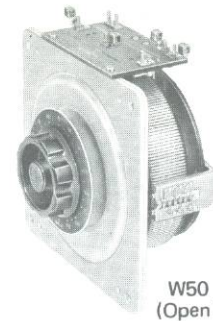

W50
(Open)

Single-phase, 240-volt input, 50-60 Hz

Output				Description										
Rated Current Amperes	Max Current Amperes	kVA	Max Output Voltage Range	Type	Mounting	Connection	W50-P1 Chokes Req'd for parallel operation	Catalog Number	Net Weight lb	Shipping Wt lb	Outline Dimensions (inches)			
											W	H	D	
2.0	2.6	0.62	0-280	W5H	◇	Open		3040-5110	6	8	4½	4¼	3¼†	
2.0	2.6	0.62	0-280	W5HM	◇	Encl		3040-5111	7	13	4⅞	6⅞	4⅞†	
2.4	3.1	0.74	0-280	W2G2	◇	Open	Series	3010-5120	7	9	3¼	3¼	7¼	
4.0	5.2	1.25	0-280	W10H	◇	Open		3070-5110	11	12	5¼	6⅞	4¼†	
4.0	5.2	1.25	0-280	W10HM	◇	Encl		3070-5111	14	17	6¼	9½	5¼†	
5.0	6.5	1.56	0-280	W5G2M		Encl	Series	3030-5121	15	23	5¼	6¼	8⅞	
6.0	7.8	1.87	0-280	W5G2	◇	Open	Series	3030-5120	14	15	4½	4¼	8	
8.0	10.4	2.50	0-280	W20H	◇	Open		3100-5110	20	23	7½	8⅞	4⅞†	
8.0	10.4	2.50	0-280	W20HM	◇	Encl		3100-5111	23	28	8⅞	11¼	5⅞†	
8.5	11.0	2.64	0-280	W8G2		Open	Series	3038-5120	16	19	4½	4¼	9⅞	
10.0	13.0	3.12	0-240	W8LG2		Open	Series 60 Hz only	3058-5120	17	19	4½	4¼	9⅞	
10.0	13.0	3.12	0-280	W10G2		Open	Series	3060-5120	25	27	5¼	6⅞	9⅞	
10.0	13.0	3.12	0-280	W10G2M		Encl	Series	3060-5121	29	34	7¼	9¼	9½	
12.0	15.6	3.74	0-280	W30H		Open		3130-5110	29	36	10	11¼	4⅞	
12.0	15.6	3.74	0-280	W30HM	◇	Encl		3130-5111	36	45	11	14¼	5¼	
16.0	20.8	4.99	0-280	W20HG2		Open	Parallel	1	3100-5120	41	46	7½	8⅞	9⅞
16.0	20.8	4.99	0-280	W20HG2M		Encl	Parallel	1	3100-5121	45	54	9	12¼	9⅞
20.0	26.0	6.24	0-280	W20G2		Open	Series	3090-5120	43	48	7½	8⅞	9⅞	
20.0	26.0	6.24	0-280	W20G2M		Encl	Series	3090-5121	48	56	9	12¼	9⅞	
20.0	31.0	7.45	0-280	W50HM		Encl		3160-5111	60	76	13¼	16¼	7¼*†	
24.0	31.2	7.5	0-280	W30HG2		Open	Parallel	1	3130-5120	59	76	10	11¼	9⅞
24.0	31.2	7.5	0-280	W30HG2M		Encl	Parallel	1	3130-5121	64	87	11¼	14¼	10⅞
25.0	32.5	7.80	0-280	W50H		Open		3160-5110	53	60	12½	13¼	6¼*†	
28.0	32.0	7.7	0-280	W30G2M		Encl	Series	3120-5121	67	90	11¼	14¼	10⅞	
30.0	36.0	8.6	0-280	W30G2		Open	Series	3120-5120	61	80	10	11¼	9⅞	
36.0	46.8	11	0-280	W30HG3		Open	Parallel	3	3130-5130	90	107	10	11¼	20⅞
36.0	46.8	11	0-280	W30HG3M		Encl	Parallel	3	3130-5131	97	120	11¼	14¼	14¼
40.0	62.0	14.9	0-280	W50HG2M	◇	Encl	Parallel	1	3160-5121	126	165	13¼	17¼	14¼
50.0	65.0	15.6	0-280	W50HG2		Open	Parallel	1	3160-5120	116	153	12½	13¼	14½
60.0	93.0	22.3	0-280	W50HG3M		Encl	Parallel	3	3160-5131	183	230	13¼	17¼	21¼
75.0	97.5	23.4	0-280	W50HG3	◇	Open	Parallel	3	3160-5130	167	214	12½	13¼	20⅞
80.0	124.0	29.8	0-280	W50HG4BBM		Encl	Parallel	4	3160-5241	255	328	13¼	17¼	27¼
100.0	130.0	31.2	0-280	W50HG4BB		Open	Parallel	4	3160-5240	230	300	12½	13¼	27¼
120.0	186.0	44.6	0-280	W50HG6BBM		Encl	Parallel	6	3160-5261	385	458	13¼	17¼	40⅞
150.0	195.0	46.8	0-280	W50HG6BB		Open	Parallel	6	3160-5260	355	428	12½	13¼	40

Single-phase, 480-volt input, 50-60Hz

2.0	2.6	1.24	0-560	W5HG2		Open	Series	3040-5120	13	15	4½	4¼	8	
2.0	2.6	1.24	0-560	W5HG2M		Encl	Series	3040-5121	15	23	5⅞	6¼	8⅞	
4.0	5.2	2.5	0-560	W10HG2		Open	Series	3070-5120	24	27	5¼	6⅞	9⅞	
4.0	5.2	2.5	0-560	W10HG2M		Encl	Series	3070-5121	29	33	7⅞	9¼	9½	
8.0	10.4	5.0	0-560	W20HG2		Open	Series	3100-5120	41	46	7½	8⅞	9⅞	
8.0	10.4	5.0	0-560	W20HG2M		Encl	Series	3100-5121	45	54	9	12¼	9⅞	
12.0	15.6	7.48	0-560	W30HG2		Open	Series	3130-5120	59	76	10	11¼	9⅞	
12.0	15.6	7.48	0-560	W30HG2M		Encl	Series	3130-5121	64	87	11¼	14¼	10⅞	
20.0	31.0	14.9	0-560	W50HG2M	◇	Encl	Series	3160-5121	126	165	13¼	17¼	14¼	
25.0	32.5	15.6	0-560	W50HG2		Open	Series	3160-5120	116	153	12½	13¼	14½	
40.0	62.0	29.8	0-560	W50HG4BBM		Encl	Parallel	2	3160-5241	255	328	13¼	17¼	27¼
50.0	65.0	31.2	0-560	W50HG4BB		Open	Parallel	2	3160-5240	230	300	12½	13¼	27¼
60.0	91.0	44.7	0-560	W50HG6BBM		Encl	Parallel	6	3160-5261	355	430	13¼	17¼	40⅞
75.0	97.5	46.8	0-560	W50HG6BB		Open	Parallel	6	3160-5260	355	428	12½	13¼	40

◇ Federal stock numbers are listed before the Index.

How to Select a Three-Phase Variac

As discussed in an earlier paragraph, selecting the proper Variac autotransformer depends on your first knowing the conditions imposed by the power line (frequency, voltage, and phase) and by the load (expressed in current or power).

To determine the needed rating for a three-phase Variac assembly, look at the individual units in the assembly and the line voltage and currents that will be imposed upon them. If the voltages and currents are within rating for the individual units, the assembly will do the job.

To control three-phase power, Variac autotransformers can be connected in either a wye configuration, which requires three units ganged (or 6, 9, or 12 for added capacity), or in an open-delta configuration, which requires two units ganged (or 4, 6, etc).

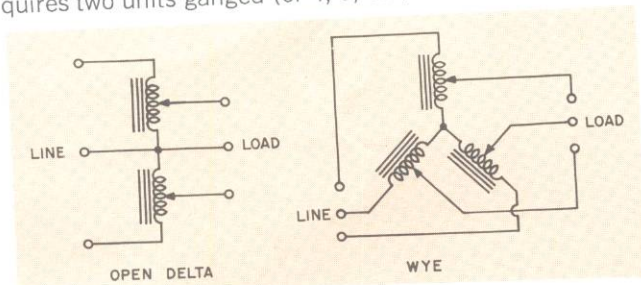

Consider the simplest cases where a single Variac unit is used in each arm. In the **wye** configuration, the full line-to-line voltage is not imposed on each unit, rather it is $1/\sqrt{3}$ or about 58% of the voltage. Thus a 240-volt line will impose about 138 volts on each unit. However, each unit supplies the full line current to the load through its brush. In the **open delta**, the input to each unit is the full voltage from the line and each unit must supply the full line current.

Line voltage Three-phase Variac assemblies are specified for the more common 208-volt, 240-volt, and 480-volt lines. The **open delta** Variac configuration is limited to the 208- and 240-volt applications and must use the Variac units with a basic rating of 240 volts; the over-

voltage connection can be used. If the **wye** is used, the three common line voltages will impose 120, 138, and 277 volts respectively on the individual units in the assembly. So, for 208-volt lines, the Variac units rated for 120 volts can be employed, and the overvoltage connection used, if desired. For 240-volt lines, either 120-volt units can be used (restricted to the line-voltage connection) or 240-volt units can be used (overvoltage permitted). For 480-volt lines, 240-volt units are usable but restricted to line-voltage connection.

Load current The current rating of the individual Variac autotransformers in the ganged assemblies is the same as the maximum line current to the load. Thus, each leg of the wye or open delta can be selected as though it were a single-phase unit. Each leg can consist of as many units paralleled (with required chokes) as is necessary to handle the current. Standard assemblies are offered with up to 12 ganged-units (a wye with four paralleled units in each leg), and even larger ones can be supplied on special order.

Load power An aid to computing the load power from the voltage and current ratings of individual components of a three-phase load, and the reverse calculations, is given in "Get more out of your Variac," later in this section. However, the kVA ratings of the three-phase Variac autotransformers require an explanation. As with single-phase units, three-phase kVA rating is the product of the maximum current and the line voltage (multiplied by $\sqrt{3}$).^{*} It should not be used in selecting a Variac when the overvoltage connection is employed, when nonlinear loads are used, or when the phase loads may be unbalanced. In those cases, the separate line currents should be calculated and compared against the rated current of the Variac.

Line frequency The selection of a W- or M-series Variac based on line frequency will be governed by the same considerations discussed earlier. Three-phase models for operation at 350 Hz and above are listed later, under 400-Hz operation.

^{*} 3 single-phase units, each with $1/\sqrt{3}$ the line voltage.

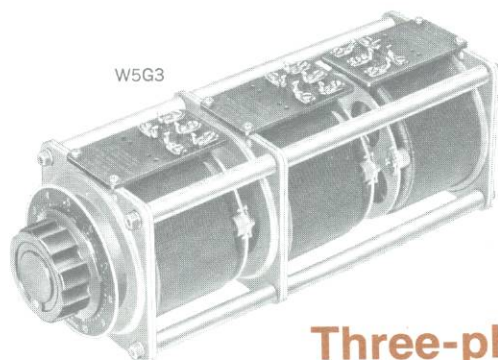

Three-phase, 208-volt input, 60-Hz only

Output					Description								
Rated Current Amperes	Max Current Amperes	kVA	Max Output Voltage Range	Type	Mounting	Connection	W50-P1 Chokes Req'd for parallel operation	Catalog Number	Net Weight lb	Shipping Wt lb	Outline Dimensions (inches)		
											W	H	D
7.1	9.2	3.31	0-208	W5LG3M	Encl	Wye		3050-5131	22	32	5 $\frac{1}{8}$	6 $\frac{3}{4}$	12 $\frac{1}{4}$
8.5	11.0	3.96	0-208	W5LG3 ◆	Open	Wye		3050-5130	20	23	4 $\frac{1}{2}$	4 $\frac{1}{2}$	12 $\frac{1}{8}$
10.0	13.0	4.68	0-208	W8LG3	Open	Wye		3058-5130	25	27	4 $\frac{1}{2}$	4 $\frac{1}{2}$	13 $\frac{3}{8}$

◆ Federal stock numbers are listed before the Index.

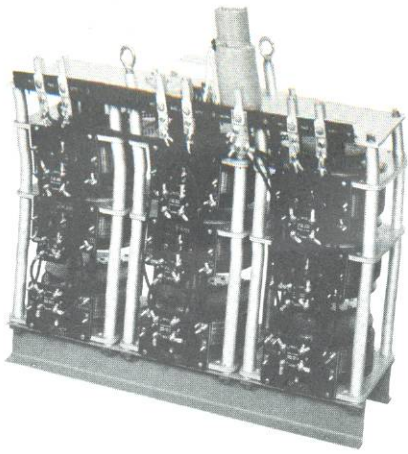

W50G9

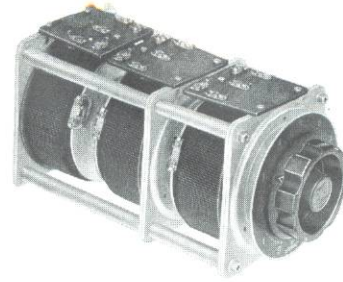

W20G3

Three-phase, 208-240-volt input, 50-60 Hz Overvoltage may be used on open delta connection or 208-volt input.

Output				Description									
Rated Current Amperes	Max Current Amperes	kVA	Max Output Voltage Range	Type	Mounting	Connection	W50-P1 Chokes Req'd for parallel operation	Catalog Number	Net Weight lb	Shipping Wt lb	Outline Dimensions (inches)		
											W	H	D
2.0	2.6	1.08	0-280	W5HG2	Open	Open Delta		3040-5120	13	15	4½	4¼	8
2.0	2.6	1.08	0-280	W5HG2M	Encl	Open Delta		3040-5121	15	23	5½	6¾	8½
2.0	2.6	1.08	0-240	W2G3M	Encl	Wye		3010-5131	12	21	4¾	5¾	12¼
2.4	3.1	1.29	0-240	W2G3	Open	Wye		3010-5130	11	13	3¼	3¼	12
4.0	5.2	2.16	0-280	W10HG2	Open	Open Delta		3070-5120	24	27	5¼	6¼	9¾
4.0	5.2	2.16	0-280	W10HG2M	Encl	Open Delta		3070-5121	29	33	7¼	9¼	9½
5.0	6.5	2.70	0-240	W5G3M	Open	Wye		3030-5131	22	32	5¼	6¾	12¼
6.0	7.8	3.24	0-240	W5G3	Encl	Wye		3030-5130	20	22	4½	4¼	12¼
8.0	10.4	4.32	0-280	W20HG2	Open	Open Delta		3100-5120	41	46	7½	8¼	9¾
8.0	10.4	4.32	0-280	W20HG2M	Encl	Open Delta		3100-5121	45	54	9	12¼	9¾
8.5	11.0	4.57	0-240	W8G3	Open	Wye		3038-5130	25	27	4½	4¼	13¼
10.0	13.0	5.40	0-240	W10G3	Open	Wye		3060-5130	37	40	5¼	6¼	14
10.0	13.0	5.40	0-240	W10G3M	Encl	Wye		3060-5131	43	47	7¼	9¼	14¾
12.0	15.6	6.48	0-280	W30HG2	Open	Open Delta		3130-5120	59	76	10	11¼	9¾
12.0	15.6	6.48	0-280	W30HG2M	Encl	Open Delta		3130-5121	64	87	11¼	14¼	10¾
20.0	26.0	10.8	0-240	W20G3	Open	Wye		3090-5130	65	71	7½	8¼	13¾
20.0	26.0	10.8	0-240	W20G3M	Encl	Wye		3090-5131	71	82	9	12¼	13¼
20.0	31.0	12.9	0-280	W50HG2M	Open	Open Delta		3160-5121	126	165	13¼	17¼	14¼
25.0	32.5	13.5	0-280	W50HG2	Open	Open Delta		3160-5120	116	153	12½	13¾	14½
28.0	32.0	13.3	0-240	W30G3M	Encl	Wye		3060-5131	99	125	11¼	14¼	14¼
30.0	36.0	15.0	0-240	W30G3	Open	Wye		3120-5130	93	113	12½	13¾	20¾
40.0	45.0	18.7	0-240	W50G3M	Encl	Wye		3150-5131	179	221	13¼	17¼	21¼
50.0	50.0	20.8	0-240	W50G3	Open	Wye		3150-5130	163	206	12½	13¾	20¾
40.0	62.0	25.8	0-280	W50HG4BBM	Encl	Open Delta	2	3160-5241	255	328	13¼	17¼	27¼
50.0	65.0	27.0	0-280	W50HG4BB	Open	Open Delta	2	3160-5240	230	300	12½	13¾	27¼
80.0	90.0	37.4	0-240	W50G6BBM	Encl	Wye	3	3150-5261	355	430	13¼	17¼	40¾
100.0	100.0	41.6	0-240	W50G6BB	Open	Wye	3	3150-5260	600	720	39	35	17
*150.0	150.0	62.4	0-240	W50G9BB	Open	Wye (chokes included)							
*200.0	200.0	83.2	0-240	W50G12BB	Open	Wye (chokes included)							
									760	880	39	41	17

Three-phase, 480-volt input, 50-60 Hz (Overvoltage connection not recommended)

2.0	2.6	2.16	0-480	W5HG3	Open	Wye		3040-5130	20	22	4½	4¼	12¼
2.0	2.6	2.16	0-480	W5HG3M	Encl	Wye		3040-5131	22	31	5½	6¾	12¼
4.0	5.2	4.32	0-480	W10HG3	Open	Wye		3070-5130	36	39	5¼	6¼	14
4.0	5.2	4.32	0-480	W10HG3M	Encl	Wye		3070-5131	42	46	7¼	9¼	14¾
8.0	10.4	8.65	0-480	W20HG3	Open	Wye		3100-5130	61	68	7¼	8¼	13¾
8.0	10.4	8.65	0-480	W20HG3M	Encl	Wye		3100-5131	67	79	9	12¼	13¼
12.0	15.6	13.0	0-480	W30HG3	Open	Wye		3130-5130	90	107	12½	13¾	20¾
12.0	15.6	13.0	0-480	W30HG3M	Encl	Wye		3130-5131	97	120	11¼	14¼	14¼
20.0	31.0	25.8	0-480	W50HG3M	Encl	Wye		3160-5131	183	230	13¼	17¼	21¼
25.0	32.5	27.0	0-480	W50HG3	Open	Wye		3160-5130	167	214	12½	13¾	20¾
40.0	62.0	51.5	0-480	W50HG6BBM	Encl	Wye	3	3160-5261	385	458	13¼	17¼	40¾
50.0	65.0	54.0	0-480	W50HG6BB	Open	Wye	3	3160-5260	355	428	12½	13¾	40
* 75.0	97.5	81.0	0-480	W50HG9BB	Open	Wye (chokes included)			610	730	39	35	17
*100.0	130	108.0	0-480	W50HG12BB	Open	Wye (chokes included)			806	926	39	41	17

* Motor drive only.

Three-phase, 560-volt input, 50-60 Hz available on request:

◆ Federal stock numbers are listed before the Index.

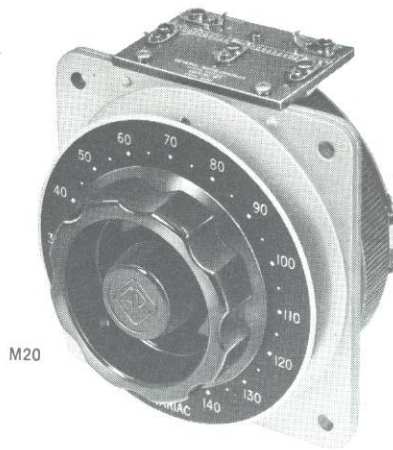

400-Hz Operation

- small, light, excellent regulation
- high- and low-temperature lubrication
- iridite-treated aluminum parts
- fungicidal treatment of all phenolic parts
- special nickel-plated brush holders

The M-series models are designed for use at frequencies between 350 and 1200 Hz. They are electrically the high-frequency equivalents of the standard W series but are much smaller and lighter than the 60-Hz models. At 400 Hz, the regulation obtained with the M-series is considerably better than with the 60-Hz models.

All M-series units conform to most military specifications for shock, vibration, salt spray, tropicalization, altitude, humidity, and temperature. See General Specifications section for further information regarding military environmental specifications. Operation of the M-series models is possible at 60 Hz if the input is limited to 60 volts. The output current remains the same and the output voltage range is 0 to 70 volts.

Single-phase, 120-volt input, 400-Hz

Output				Description								
Rated Current Amperes	Max Current Amperes	kVA	Max Output Voltage Range	Type	Mounting	Connection	Catalog Number	Net Weight lb	Shipping Wt lb	Outline Dimensions (inches)		
										W	H	D
2.4	3.1	0.37	0-140	M2	◇	Open		2	3	3¼	3⅛	2⅛†
6.0	7.8	0.94	0-140	M5	◇	Open		3	4	4½	4⅛	2⅛†
10.0	13.0	1.56	0-140	M10	◇	Open		6	8	5¼	6⅞	3⅛†
20.0	26.0	3.12	0-140	M20	◇	Open		13	15	7½	8⅞	3⅞†

Three-phase, 120-volt input, 400-Hz

2.4	3.1	0.65	0-140	M2G2	◇	Open	Open Delta	4	5	3¼	3⅛	5⅞
6.0	7.8	1.62	0-140	M5G2	◇	Open	Open Delta	7	8	4½	4⅛	5½
10.0	13.0	2.7	0-140	M10G2	◇	Open	Open Delta	12	16	5¼	6⅞	6⅛
20.0	26.0	5.4	0-140	M20G2	◇	Open	Open Delta	26	30	7	8⅞	7⅞

Three-phase, 120-208-240-volt, 400-Hz

2.4	3.1	1.30	0-240*	M2G3	◇	Open	Wye	5	7	3½	3⅛	8¼
6.0	7.8	3.24	0-240*	M5G3	◇	Open	Wye	10	12	4½	4⅛	8⅞
10.0	13.0	5.4	0-240*	M10G3	◇	Open	Wye	19	23	5¼	6⅞	10¼
20.0	26.0	10.8	0-240*	M20G3	◇	Open	Wye	38	43	7½	8⅞	10¾

* 17% overvoltage connection is permitted on 120/208, three-phase lines.

◇ Federal stock numbers are listed before the Index.



W8MT3VM



W8MT3

Portable Variac® Autotransformers

Portable, metered, cased units are available in twenty models for use in the laboratory and on the test bench. Each consists of a Variac autotransformer and an overload protector. Some models have a voltmeter, ammeter, and wattmeter in different configurations.

Adequate meter shielding is provided to reduce stray fields sufficiently to give over-all meter accuracy of 3% of full scale (5% of full scale for the powerful W20HMT3A).

The output circuit is protected by either a Klixon* thermal overload breaker, resettable from the panel, or by easily accessible and replaceable fuses.

A double-pole on-off switch disconnects both sides of the line. Where dual-range meters are used, make-before-break range switches permit switching under load. All have convenient carrying handles. Some models come in both 2- and 3-wire versions.

* Registered trademark of Texas Instruments Inc.

Single-phase, 120-volt input, 50-60 Hz

Rated Current Amperes	Output			Type	Meter Ranges (full scale)			2- or 3-wire cord and receptacle	Catalog Number	Net Weight lb	Shipping Wt lb	Outline Dimensions (inches)		
	Max Current Amperes	Max Output Voltage Range			Amperes	Watts	Volts					W	H	D
5.0	—	0-140	—	W5MT	—	—	—	2	3030-5118	8	15	4 ⁷ / ₈	6 ¹ / ₈	4 ³ / ₈ *†
5.0	—	0-140	—	W5MT3	—	—	—	3	3030-5119	8	15	4 ⁷ / ₈	6 ¹ / ₈	4 ³ / ₈ *†
5.0	—	0-140	—	W5MT3VM	—	—	150	3	3030-5015	8	19	4 ⁷ / ₈	6 ¹ / ₈	4 ³ / ₈
5.0	—	0-140	—	W5MT3A	1/5	—	150	3	3030-5012	11	19	6 ³ / ₄	9 ¹ / ₂	5 ¹ / ₄
5.0	—	0-140	—	W5MT3W	—	150/750	150	3	3030-5013	12	19	6 ³ / ₄	9 ¹ / ₂	5 ¹ / ₄
5.0	—	0-140	—	W5MT3AW	1/5	150/750	150	3	3030-5014	12	21	11 ¹ / ₂	8 ³ / ₈	5 ³ / ₈
7.1	—	0-120	—	W5LMT3 ¹	—	—	—	3	3050-5119	8	18	4 ⁷ / ₈	6 ¹ / ₈	4 ³ / ₈
10.0	—	0-140	—	W8MT3	—	—	—	3	3038-5119	10	16	5 ³ / ₈	7	6 ¹ / ₈
10.0	—	0-140	—	W8MT3VM	—	—	150	3	3038-5015	10	16	5 ³ / ₈	7	6 ¹ / ₈
10.0	—	0-140	—	W10MT	—	—	—	2	3060-5118	16	24	6 ³ / ₄	9 ¹ / ₂	5 ¹ / ₄ †
10.0	—	0-140	—	W10MT3	—	—	—	3	3060-5119	16	24	6 ³ / ₄	9 ¹ / ₂	5 ¹ / ₄ †
10.0	—	0-140	—	W10MT3A	2/10	—	150	3	3060-5012	18	30	8 ³ / ₈	11 ¹ / ₈	5 ³ / ₈
10.0	—	0-140	—	W10MT3W	—	300/1500	150	3	3060-5013	18	30	8 ³ / ₈	11 ¹ / ₈	5 ³ / ₈
18.0	—	0-140	—	W20MT3A	20	—	150	3	3090-5012	27	34	8 ³ / ₈	11 ¹ / ₈	5 ³ / ₈
18.0	—	0-140	—	W20MT3	—	—	—	3	3090-5119	20	23	8 ³ / ₈	11 ¹ / ₈	5 ³ / ₈ †

¹ 60 Hz only

Single-phase, 240-volt input, 50-60 Hz

2.0	—	0-280	—	W5HMT	—	—	—	2	3040-5118	8	15	4 ⁷ / ₈	6 ¹ / ₈	4 ³ / ₈ †
4.0	—	0-280	—	W10HMT	—	—	—	2	3070-5118	15	24	6 ³ / ₄	9 ¹ / ₂	5 ¹ / ₄
4.0	—	0-280	—	W10HMT3	—	—	—	3	3070-5119	15	24	6 ³ / ₄	9 ¹ / ₂	5 ¹ / ₄
8.0	—	0-280	—	W20HMT3	—	—	—	3	3100-5119	27	35	8 ³ / ₈	11 ¹ / ₈	5 ³ / ₈ †
8.0	—	0-280	—	W20HMT3A	10	—	300	3	3100-5012	25	31	8 ³ / ₈	11 ¹ / ₈	5 ³ / ₈

Types MT and MT3 have overvoltage connections and corresponding dial scales, but can be supplied on special order with line-voltage connections and dial scales.

* Listed under Re-examination Service of Underwriters' Laboratory.

† Approved by Canadian Standards Association.

◆ Federal stock numbers are listed before the Index.

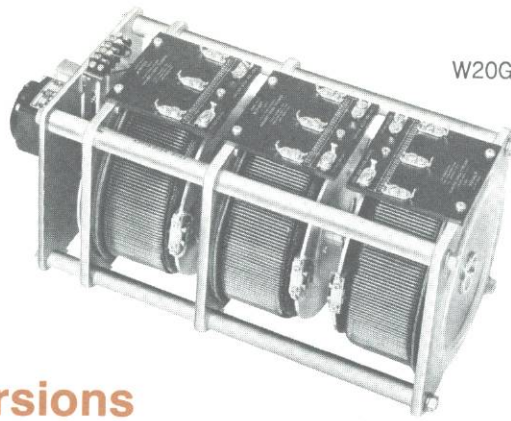

W20G3D8CK

Motor-Drive Versions

ORDERING INFORMATION

From table: yes = available from stock
so = available on special order

Establishing correct type number:

1. Select basic Variac type number; e.g., W5G2 (a 2-gang W5-series Variac)
2. Select time desired for full 320° traverse and insert time in "D-CK"
3. Arrange in following order:
W5G2D8CK (a 2-gang W5-series Variac with motor drive, 8-second traverse)
4. If fully enclosed case is desired, add "M", e.g., W5G2D8CKM.

Dimensions: Width and height are same as for component Variac. Depth is approx 6 inches greater than that of equivalent manually operated model.

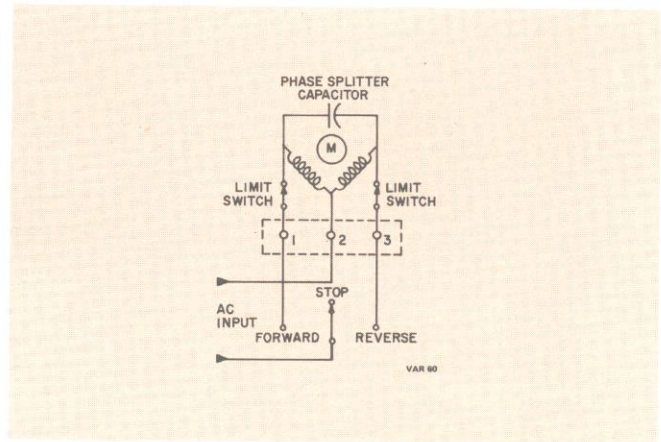

Schematic diagram of motor circuit

Seconds for full 320° Traverse*								Shipping Weight (lb)		Seconds for full 320° Traverse*								Shipping Weight (lb)	
	2	4	8	16	32	64	128	Cased	Uncased		2	4	8	16	32	64	128	Cased	Uncased
M2	yes	yes	yes	yes	yes	yes	...	9	...	W10	yes	yes	yes	yes	yes	yes	yes	23	30
M2G2	yes	yes	yes	yes	yes	yes	...	11	...	W10G2	so	so	yes	yes	yes	yes	yes	35	43
M2G3	...	yes	yes	yes	yes	yes	...	14	...	W10G3	so	so	yes	yes	yes	yes	yes	47	56
M5	yes	yes	yes	yes	yes	yes	...	14	...	W10H	yes	yes	yes	yes	yes	yes	yes	23	30
M5G2	yes	yes	yes	yes	yes	yes	...	16	...	W10HG2	so	yes	yes	yes	yes	yes	yes	35	43
M5G3	...	yes	yes	yes	yes	yes	...	19	...	W10HG3	so	so	yes	yes	yes	yes	yes	47	56
M10	yes	yes	yes	yes	yes	yes	yes	16	...	W20	so	yes	yes	yes	yes	yes	yes	35	50
M10G2	so	yes	yes	yes	yes	yes	yes	22	...	W20G2	so	so	yes	yes	yes	yes	yes	54	71
M10G3	so	so	yes	yes	yes	yes	yes	29	...	W20G3	so	so	yes	yes	yes	yes	yes	78	97
M20	...	yes	yes	yes	yes	yes	yes	27	...	W20H	so	yes	yes	yes	yes	yes	yes	35	47
M20G2	so	so	yes	yes	yes	yes	yes	47	...	W20HG2	so	so	yes	yes	yes	yes	yes	54	69
M20G3	so	so	yes	yes	yes	yes	yes	58	...	W20HG3	so	so	yes	yes	yes	yes	yes	77	93
W2	yes	yes	yes	yes	yes	yes	...	13	15	W30	so	yes	yes	yes	yes	yes	yes	57	79
W2G2	yes	yes	yes	yes	yes	yes	...	15	17	W30G2	...	so	so	yes	yes	yes	yes	89	98
W2G3	...	yes	yes	yes	yes	yes	...	17	20	W30G3	so	so	yes	yes	yes	120	120
W5	yes	yes	yes	yes	yes	yes	...	17	20	W30H	so	yes	yes	yes	yes	yes	yes	55	78
W5G2	yes	yes	yes	yes	yes	yes	...	23	26	W30HG2	...	so	so	yes	yes	yes	yes	88	98
W5G3	...	yes	yes	yes	yes	yes	...	33	39	W30HG3	so	so	yes	yes	yes	120	120
W5H	yes	yes	yes	yes	yes	yes	...	18	20	W50	...	so	so	yes	yes	yes	yes	95	125
W5HG2	yes	yes	yes	yes	yes	yes	...	25	28	W50G2	so	so	yes	yes	yes	162	194
W5HG3	...	yes	yes	yes	yes	yes	...	34	38	W50G3	so	so	yes	yes	yes	220	242
W5L	yes	yes	yes	yes	yes	yes	...	17	20	W50G4	so	so	so	so	yes	295	330
W5LG2	yes	yes	yes	yes	yes	yes	...	24	29	W50G6	so	so	so	so	yes	411	454
W5LG3	...	yes	yes	yes	yes	yes	...	27	32	W50G9	yes
W8	yes	yes	yes	yes	yes	yes	...	19	...	W50G12	yes
W8G2	yes	yes	yes	yes	yes	yes	...	28	...	W50H	...	so	so	yes	yes	yes	yes	100	130
W8G3	...	yes	yes	yes	yes	yes	...	37	...	W50HG2	so	so	yes	yes	yes	167	201
W8L	yes	yes	yes	yes	yes	yes	...	19	...	W50HG3	so	so	yes	yes	yes	222	246
W8LG2	yes	yes	yes	yes	yes	yes	...	28	...	W50HG4	so	so	so	so	yes	302	334
W8LG3	...	yes	yes	yes	yes	yes	...	37	...	W50HG6	so	so	so	so	yes	480	526
										W50HG9	yes
										W50HG12	yes

* Motor times given for 60-Hz operation. Add 20% more time for 50-Hz operation.

Variac® autotransformer — Type W2

Basic data for single section:

Input	120 V, 50 to 60 Hz
Output as % of input	0 to 117%
Rated Current	2.4 A
Maximum Current	3.1 A
No-Load Loss at 60 Hz	3.5 W
Number of Turns	403
DC Resistance of Winding	10.35 Ω
Drive Torque (ounce-inches)	5 to 10
Replacement Brush	VB-1

Dimensions Types W2 and W2M

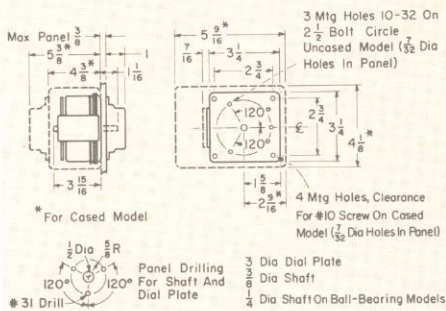

Dimensions Ganged Uncased Types W2G2 and W2G3

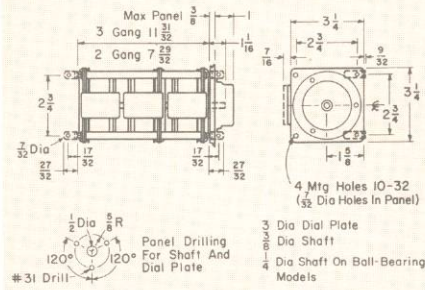

Dimensions Ganged Cased Types W2G2M and W2G3M

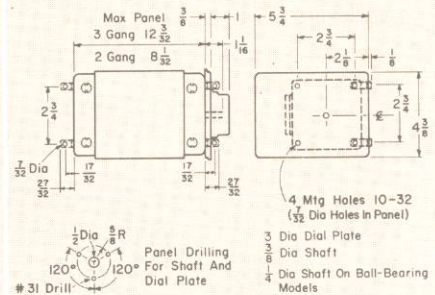

Variac® autotransformer — Type W5

Basic data for single section:

	W5	W5L	W5H
Input	120 V, 50 to 60 Hz	120 V, 60 Hz	240 V, 50 to 60 Hz
Output as % of input	0 to 117%	0 to 100%	0 to 117%
Rated Current	6 A	8.5 A	2 A
Maximum Current	7.8 A	11 A	2.6 A
No-Load Loss at 60 Hz	9 W	12 W	9 W
Number of Turns	293	235	590
DC Resistance of Winding	1.85 Ω	0.92 Ω	17 Ω
Drive Torque (ounce-inches)	10 to 20	10 to 20	10 to 20
Replacement Brush	VB-2	VB-2	VB-1

Dimensions Types W5, W5L, W5M, W5LM, W5MT, W5MT3, W5LMT3, W5H, W5HM, and W5HMT

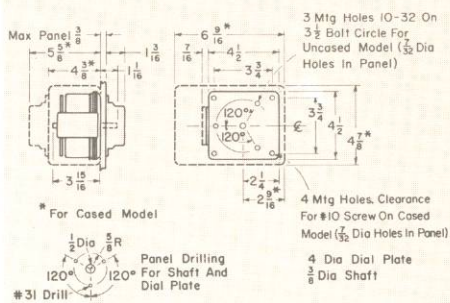

Dimensions Ganged (Uncased) Types W5G2, W5G3, W5HG2, W5HG3, W5LG2 and W5LG3

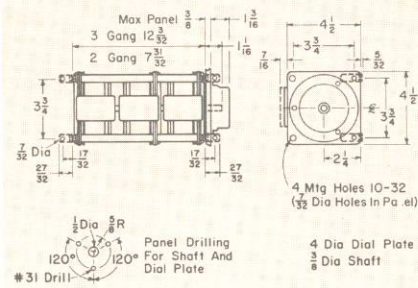

Dimensions Ganged Cased Types W5G2M, W5G3M, W5HG2M, W5HG3M, W5LG2M, and W5LG3M

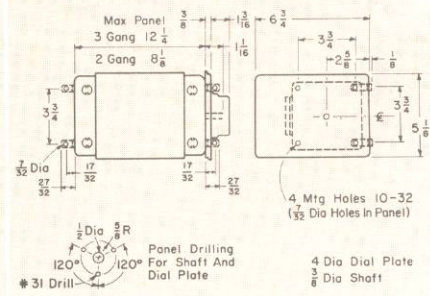

Variac® autotransformer — Type W8

Basic data for single section:

	W8	W8L
Input	120 V, 50 to 60 Hz	120 V, 60 Hz
Output as % of input	0 to 117%	0 to 100%
Rated Current	8.5 A	10 A
Maximum Current	11 A	13 A
No-Load Loss at 60 Hz	12 W	12 W
Number of Turns	236	184
DC Resistance of Winding	1 Ω	0.5 Ω
Drive Torque (ounce-inches)	10 to 20	10 to 20
Replacement Brush	VB-3	VB-3

Dimensions Types W8 and W8L

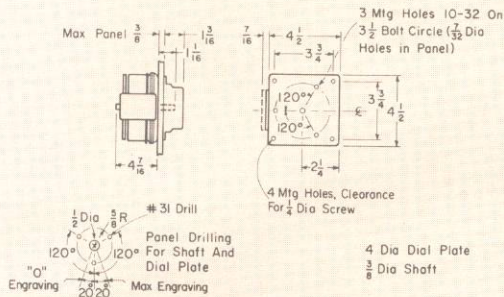

Dimensions Ganged
Types W8G2, W8G3, W8LG2,
and W8LG3

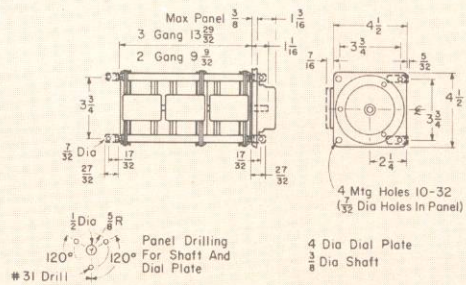

Variac® autotransformer — Type W10

Basic data for single section:

	W10	W10H
Input	120 V, 50 to 60 Hz	240 V, 50 to 60 Hz
Output as % of Input	0 to 117%	0 to 117%
Rated Current	10 A	4 A
Maximum Current	13 A	5.2 A
No-Load Loss at 60 Hz	17 W	17 W
Number of Turns	212	430
DC Resistance of Winding	0.58 Ω	4.85 Ω
Drive Torque (ounce-inches)	15 to 30	15 to 30
Replacement Brush	VBT-10	VBT-11

Dimensions Types W10, W10M,
W10MT, W10MT3, W10H, W10HM,
W10HMT, and W10HMT3.

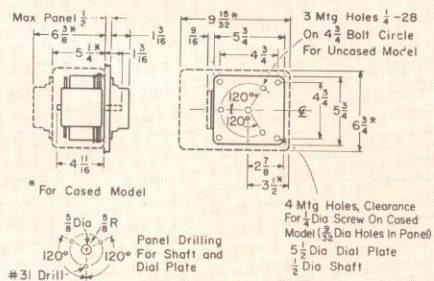

Dimensions Ganged Uncased
Types W10G2, W10G3, W10HG2,
and W10HG3

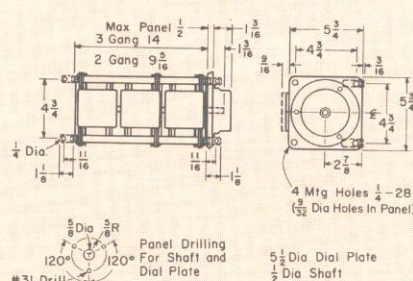

Dimensions Cased Types W10G2M,
W10G3M, W10HG2M, and
W10HG3M

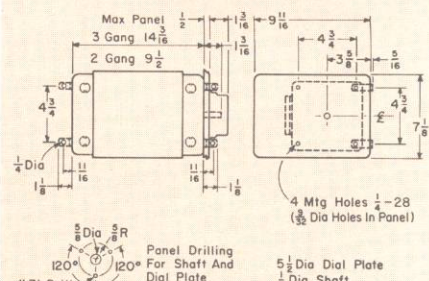

Variac® autotransformer — Type W20

Basic data for single section:	W20	W20H
Input	120 V, 50 to 60 Hz	240 V, 50 to 60 Hz
Output as % of Input	0 to 117%	0 to 117%
Rated Current	20 A	8 A
Maximum Current	26 A	10.4 A
No-Load Loss at 60 Hz	27 W	27 W
Number of Turns	169	339
DC Resistance of Winding	0.21 Ω	1.6 Ω
Drive Torque (ounce-inches)	45 to 90	45 to 90
Replacement Brush	VBT-8	VBT-12

Dimensions Types W20, W20M, W20MT3, W20H, W20HM and W20HMT3.

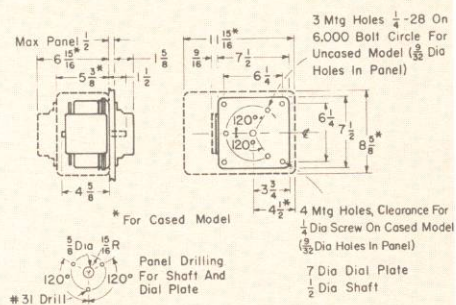

Dimensions Ganged Uncased Types W20G2, W20G3, W20HG2 and W20HG3

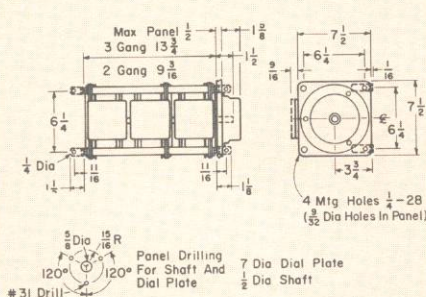

Dimensions Ganged Cased Types W20G2M, W20G3M, W20HG2M, and W20HG3M

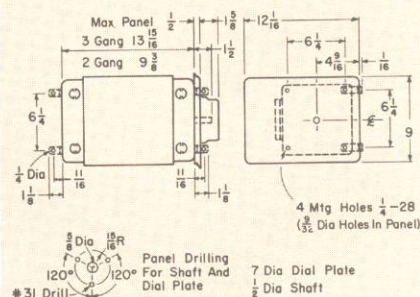

Variac® autotransformer — Type W30

Basic data for single section:	W30	W30H
Input	120 V, 50 to 60 Hz	240 V, 50 to 60 Hz
Output as % of Input	0 to 117%	0 to 117%
Rated Current	30 A	12 A
Maximum Current	36 A	15.6 A
No-Load Loss at 60 Hz	35 W	35 W
Number of Turns	184	367
DC Resistance of Winding	0.14 Ω	1.17 Ω
Drive Torque (ounce-inches)	50 to 100	50 to 100
Replacement Brush	VBT-13	VBT-14

Dimensions Types W30, W30M, W30H, and W30HM

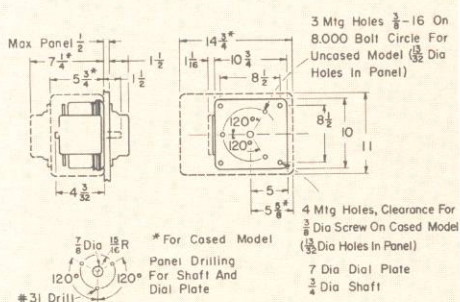

Dimensions Ganged Uncased Types W30G2, W30G3, W30G4, W30G6, W30HG2, W30HG3, W30HG4, and W30HG6

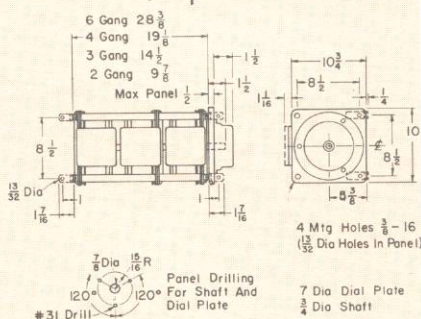

Dimensions Ganged Cased Types W30G2M, W30G3M, W30G4M, W30G6M, W30HG2M, W30HG3M, W30HG4M, and W30HG6M

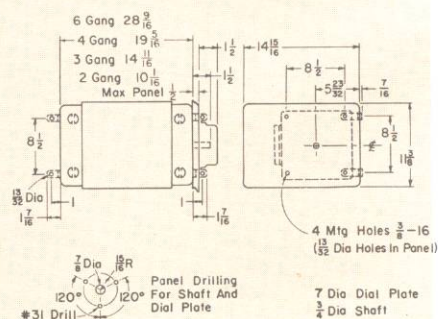

Variac® autotransformer – Type W50

Basic data for single section:	W50	W50H
Input	120 V, 50 to 60 Hz	240 V, 50 to 60 Hz
Output as % of Input	0 to 117%	0 to 117%
Rated Current	50 A	25 A
Maximum Current	50 A	32.5 A
No-Load Loss at 60 Hz	50 W	50 W
Number of Turns	186	294
DC Resistance of Winding	0.08 Ω	0.3 Ω
Drive Torque (ounce-inches)	150 to 300	150 to 300
Replacement Brush	VBT-6	VBT-7

Dimensions Types W50, W50M, W50H and W50HM

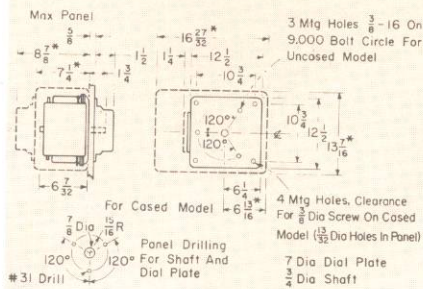

Dimensions Ganged Uncased Types W50G2, W50G3, W50G4, W50G6, W50HG2, W50HG3, W50HG4 and W50HG6

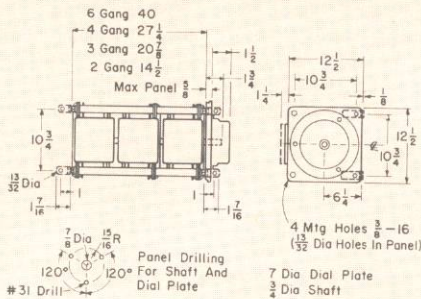

Dimensions Ganged Cased Types W50G2M, W50G3M, W50G4M, W50G6M, W50HG2M, W50HG3M, W50HG4M, and W50HG6M

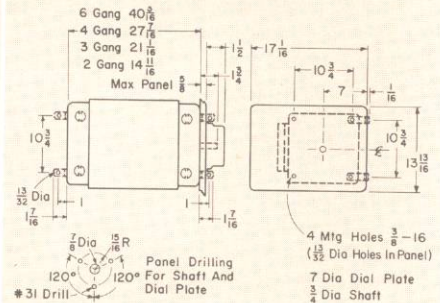

Variac® autotransformer – M-Series

Basic data for single section:	M2	M5	M10	M20
Input	120 V, 350 to 1200 Hz	120 V, 350 to 1200 Hz	120 V, 350 to 1200 Hz	120 V, 350 to 1200 Hz
Output as % of Input	0 to 117%	0 to 117%	0 to 117%	0 to 117%
Rated Current	2.4 A	6 A	10 A	20 A
Maximum Current	3.1 A	7.8 A	13 A	26 A
No-Load Loss at 400 Hz	3.5 W	9 W	17 W	27 W
Number of Turns	403	294	212	169
DC Resistance of Winding	6.25 Ω	1.2 Ω	0.36 Ω	0.15 Ω
Drive Torque (ounce-inches)	5 to 10	10 to 20	15 to 30	45 to 90
Replacement Brush	VB-1	VB-2	VBT-10	VBT-8

Dimensions Type M Variacs

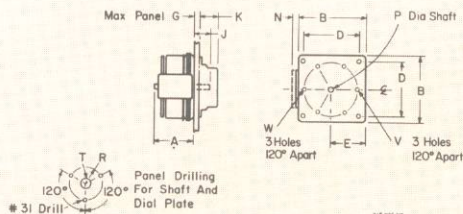

TYPE	A	B	D	E	G	J	K	N	P	R	T	V	W
M2	2 1/16"	3 1/4"	2 3/4"	1 5/8"	3/8"	1 1/16"	1"	1/16"	3/8"	5/8"	1/2"	10-32	—
M5	2 1/16"	4 1/2"	3 3/4"	2 1/4"	3/8"	1 1/16"	1 1/16"	1/16"	3/8"	5/8"	1/2"	—	10-32
M10	3 1/16"	5 3/4"	4 3/4"	2 7/8"	1/2"	1 13/16"	1 3/16"	3/16"	1/2"	5/8"	5/8"	—	1/4-28
M20	3 5/8"	7 1/2"	6 1/4"	3 3/4"	1/2"	1 1/2"	1 5/8"	1/8"	1/2"	15/16"	5/8"	—	1/4-28

Dimensions Type M Ganged Variacs

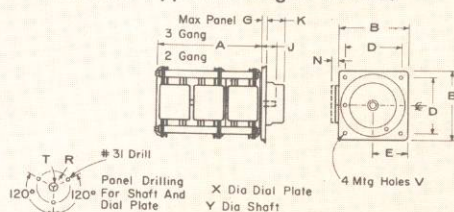

TYPE	A	B	D	E	G	J	K	N	R	T	V	X	Y
M2G2	5 13/32"	3 1/4"	2 3/4"	1 5/8"	3/8"	1 1/16"	1"	1/16"	3/8"	1/2"	10-32	3"	3/8"
M2G3	8 1/32"	3 1/4"	2 3/4"	1 5/8"	3/8"	1 1/16"	1"	1/16"	3/8"	1/2"	10-32	3"	3/8"
M5G2	5 13/32"	4 1/2"	3 3/4"	2 1/4"	3/8"	1 1/16"	1 3/16"	1/16"	3/8"	1/2"	10-32	4"	3/8"
M5G3	8 1/32"	4 1/2"	3 3/4"	2 1/4"	3/8"	1 1/16"	1 3/16"	1/16"	3/8"	1/2"	10-32	4"	3/8"
M10G2	6 13/16"	5 3/4"	4 3/4"	2 7/8"	1/2"	1 1/16"	1 3/16"	3/16"	1/2"	5/8"	1/4-28	5 1/2"	1/2"
M10G3	10 1/4"	5 3/4"	4 3/4"	2 7/8"	1/2"	1 1/16"	1 3/16"	3/16"	1/2"	5/8"	1/4-28	7"	1/2"
M20G2	7 3/16"	7 1/2"	6 1/4"	3 3/4"	1/2"	1 1/2"	1 5/8"	1/8"	1 1/16"	5/8"	1/4-28	7"	1/2"
M20G3	10 3/4"	7 1/2"	6 1/4"	3 3/4"	1/2"	1 1/2"	1 5/8"	1/8"	1 1/16"	5/8"	1/4-28	7"	1/2"

Get More Out of Your Variac

Careful overloading of a Variac® autotransformer can take advantage of many design trade-offs.

For example, the current ratings of all models assume trouble-free operation 24 hours a day, day after day. If a Variac is to be used only 2 hours or less per day, significantly more than rated current can be drawn for that short period. Figure 1 (general specifications) illustrates how up to 10 times the normal rating can be realized.

Also, if the load is frequently switched on and off, the duty ratio of that cycle can permit enough cooling during the off time to allow intentional overloading. A detailed discussion of this consideration appears below.

Finally, certain types of load permit the Variac rating to be increased, as reflected in Variac specifications.

Match the Variac to the load To enable the user to get the most out of a Variac autotransformer, General Radio specifies the current rating with two different numbers, rated current and maximum current. Briefly, remember that maximum current can be drawn from the autotransformer only when the output voltage is set near line voltage. Rated current, on the other hand, can be drawn at any setting of the Variac and is the only rating applicable when the overvoltage connection of the Variac is employed.

There are two basic categories of load (linear and non-linear) and the Variac cannot supply as much current at

a mid-range setting as it can near the extremes without overheating. In Figure 3, the sagging dashed line plots the reduction in the current capacity at mid-range. (With an output of 50% of line voltage, there is the greatest internal heating per ampere of output current.)

The straight black line shows the current that a well-behaved constant-impedance load will draw through the Variac as the voltage is decreased from maximum. Note that, even though maximum current is drawn at maximum voltage, the line stays well below the reduced capacity level at mid range. Typical of this kind of load is a heating element.

Unfortunately, all loads don't behave so well, incandescent lights in particular. They react to a decreasing voltage much as shown by the curved solid line. The current they draw drops very little even as the voltage is cut to 50% of maximum. If a load of this type is permitted to draw maximum current at maximum voltage, it will obviously exceed the Variac capacity at mid-range, causing overheating and reduced life. A Variac with larger current capacity must be chosen so the load will not exceed its rated current and thus remain within bounds at mid-range.

So, for many loads, the maximum current rating permits greater performance without risk, while for other common loads, the rated current specification is a neces-

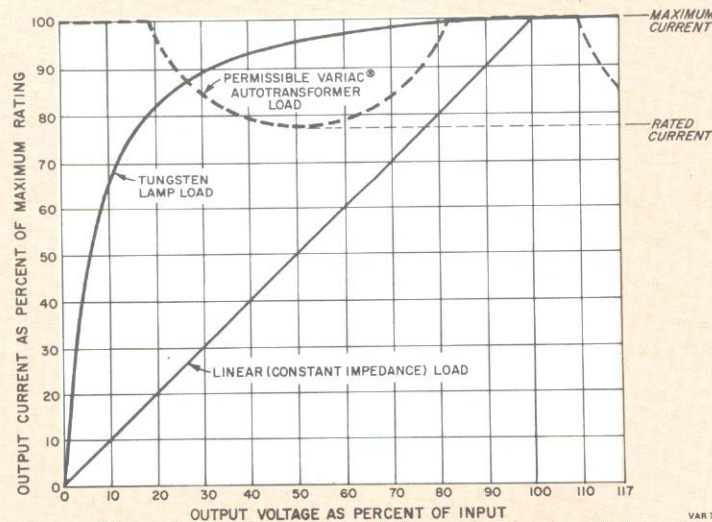

Figure 3. Typical load-current curves.

sary guard against overheating. To limit the specification to but one number would mean either unnecessary caution or undesirable risk; neither would permit full utilization of the Variac capability.

As to the limit on current when the overvoltage connection is used, the dashed line again sags very quickly out beyond the 100%-of-line-voltage point down to the rated-current value. Thus, at 117% of line, the most current that should be drawn is the rated value.

Effect of duty cycle When the load is continuously cycled on and off, the rating should be determined as follows. The duty-cycle is defined as the ratio of "off-plus-on" time to "on" time; the rated current can be multiplied by the square root of this ratio to obtain the allowable uprated current. The following examples will illustrate the calculation of permissible overloads for the Type W5 model, whose rated current is 6 amperes.

Example 1: The load is on for 15 seconds out of every 4 minutes (240 seconds).

$$\sqrt{\text{duty cycle}} = \sqrt{\frac{240}{15}} = 4$$

duty-cycle uprated current = 6 A × 4 = 24 A

From Figure 1 in the "General Specifications," a 15-second overload uprates the current by 500% so that

short-term overload current = 6 A × 5 = 30 A

Since the lower rating takes precedence, the 24-A limitation imposed by the duty ratio is the maximum current permissible. Note, on the overload curve of Figure 1, the lower curve must be used for models with built-in fuses.

Example 2: The load is on for 6 seconds out of each minute (60 seconds) over a duration of one-half hour.

$$\sqrt{\text{duty cycle}} = \sqrt{\frac{60}{6}} = 3.16$$

short-term overload for 30 minutes = 133%

from duty-cycle and 30-minute short-term overload considerations:

uprated current = 6 A × 3.16 × 1.33 = 24.6 A

short-term overload current = 6 A × 7.25 = 42.7 A

Since the lower rating takes precedence, the 24.6-A limitation imposed by the duty-cycle and 30-minute short-term overload is the maximum current permissible.

Three-phase load calculations If the three-phase-load unit is marked with rated line-voltage and current or load-power (kVA), you can easily select a Variac from the foregoing tables.

If, however, the ratings are known only for the individual three elements of the load, you must do some figuring to arrive at the values needed to use the selection tables.

Consider, for example, three heater elements, each rated at 1.4 kVA and 240 V, which are connected in a delta configuration as in Figure 4a. To deliver full power, they must be connected, through a Variac to provide control, to a 240-V line. The current each Variac must supply, I_{load} , is $\sqrt{3}$ times larger than the current in each element of a delta load:

$$I_{\text{load}} = \sqrt{3} \frac{1400 \text{ (VA)}}{240 \text{ V}} = 10.1 \text{ A}$$

In the table of 3-phase 240-V models, the first type listed with adequate "maximum current" rating is the W20HG2. It has two drawbacks, however: It cannot supply overvoltage output (since that means limiting the output to the "rated current" value), and it is not the most economical selection. The W8G3 Variac is considerably less expensive but cannot supply overvoltage either, for a different reason: It must be wired in a wye

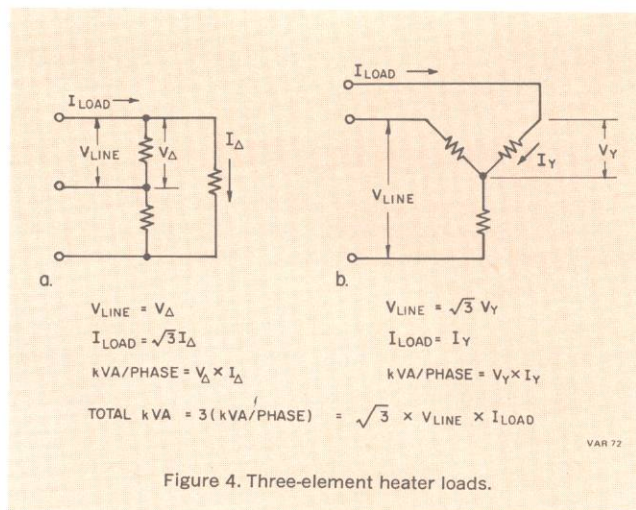

Figure 4. Three-element heater loads.

configuration in which the maximum voltage allowed, 140 V, will be applied to each unit in the assembly, thus preventing added voltage from being developed for the load. To get overvoltage capability, find, in the table, the next model that is wired in an open delta and has adequate "maximum current" rating: The W30HG2. A quick look at larger open-delta assemblies confirms that this is the least expensive choice.

Now consider three heater elements, each rated at 1.0 kVA and 120 V, which are connected in a wye as in Figure 4b. To deliver full power, each element must have 120 V applied. Since the line voltage across a wye is $\sqrt{3}$ times that across each arm, the needed line voltage is 208 V. Each arm will draw 1000 VA/120 V or 8.3 A from each Variac. From the specifications for three-phase units, select the W5LG3 as having adequate "maximum current" rating. However, the W5LG3 cannot supply overvoltage. If you want the overvoltage feature, you need a W8G3, based on its rated current.

Note that the configuration, open-delta or wye, of the load and the Variac do not have to match.

Voltage doubling In normal use, a Variac supplies an output of from 0 to line voltage (or slightly higher when the overvoltage connection is used). On the 240-V (H) models, a provision has been made to apply 120 V and get a 0-to-280-V output. This step-up of 2.33 is accomplished by the application of the high side of the line to either terminal 6 or 7 on the input of the Variac.

Because of the step-up action, the current in the "primary" of the autotransformer is approximately twice the output (brush) current rather than equal to the brush current as it is in the normal connection. Therefore the permissible load current is one half the standard rating for the unit. For example, the rated current for a W10H is 4 A for a 240-V input and 0-to-280-V output. But for a 120-V input and 0-to-240-V output, the rated current for the same unit is only 2 A.

W50-P1 Paralleling Choke

Many of the Variac® autotransformers listed on the preceding pages are indicated to require one or more Type W50-P1 Chokes. This unit is used when two or more autotransformer outputs are to be connected in parallel; it prevents the flow of potentially damaging currents from one unit to the other. Instructions for proper interconnecting are included with each unit.

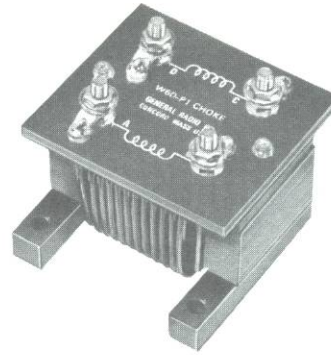

Description	Catalog Number
W50-P1 Choke	3150-5016

Replacement Brushes

Occasionally, as a result of accident or excessive wear or current, it may be necessary to replace the autotransformer's carbon brush or brushes. They may be ordered from the table below.

Description	Catalog Number
VB-1 Brush, for M2, W2, W5H	3200-5901
VB-2 Brush, for M5, W5, W5L	3200-5900
VB-3 Brush, for W8, W8L	3200-5923
VBT-10 Brush, for M10, W10	3200-5910
VBT-11 Brush, for W10H	3200-5911
VBT-8 Brush Set, for M20, W20	3200-5908
VBT-12 Brush Set, for W20H	3200-5912
VBT-13 Brush Set, for W30	3200-5913
VBT-14 Brush Set, for W30H	3200-5914
VBT-6 Brush Set, for W50	3200-5906
VBT-7 Brush Set, for W50H	3200-5907

Minivolt* adjustable autotransformer

- pocket sized
- efficient
- ideal for low-voltage control

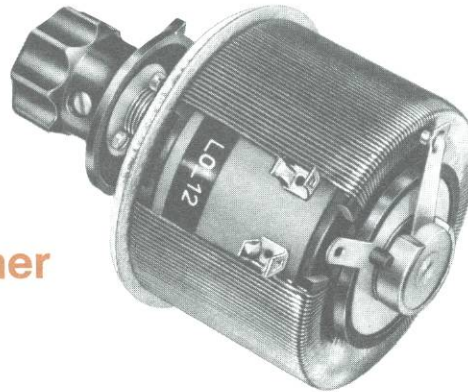

To save you weight and space, for low-voltage applications, we bring you the Minivolt* adjustable autotransformer. Like the larger members of the Variac® family, it provides smooth, wide-range control — from zero to full input voltage. Likewise, it provides the efficiency and minimal regulation (low source impedance) of a well-designed transformer — far superior to that obtainable with a rheostat of similar size.

Mounts in a single panel hole. The open construction is neat and functional. Three versions are offered; choose the one suited to your input voltage.

Note: This product is manufactured exclusively in Europe. A complete line of Variac® adjustable autotransformers (not listed in this catalog) is also manufactured there.

Description	Catalog Number
Minivolt* adjustable autotransformer	3230-5000
LO-12, 12-volt	3230-5001
LO-24, 24-volt	3230-5002
LO-36, 36-volt	3230-5003

SPECIFICATIONS

Ratings:

Type	Output Voltage	Current	
		Rated	Max
LO-12	0 to 12 V	3.0	3.9 A
LO-24	0 to 24 V	1.2	1.5 A
LO-36	0 to 36 V	0.6	0.8 A

Frequency: 50-60 Hz.

Mechanical: Open construction, panel mounting. DIMENSIONS (AxBxC): 1.81x1.62x1.06 in. (46x41x27 mm). WEIGHT: 0.66 lb (0.3 kg) net.

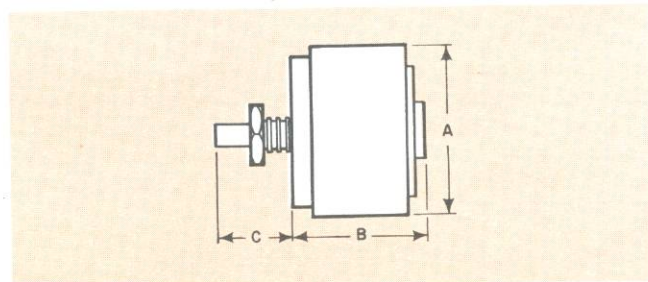

* A registered trademark owned by General Radio France, a subsidiary of General Radio Company.

◆ Federal stock numbers are listed before the Index.